

The

# Hutchison File

compiled by Pelayo Calante  
and A. Michrowski

THE PLANETARY ASSOCIATION FOR CLEAN ENERGY, Inc.

The

# *Hutchison File*

*from the Association's archives*

compiled by Pelayo Calante  
and A. Michrowski

**THE PLANETARY ASSOCIATION  
FOR CLEAN ENERGY, Inc.**

ISBN 0-919969-34-8  
1996

## **Acknowledgments**

We are grateful for the support to the production of this document to the following individuals (in alphabetical order):

Louise Dagenais, George Hathaway, Jeanne Manning,  
Monique Michaud, Lioudmila Ten, Marion Van Goudover  
and Charles A. Yost.

## Contents

Date Chart		2
The Hutchison effect apparatus		5
Description of the "Hutchison Effect"		13
The inside view		40
Independent assessments explaining the effect:		
<i>Psychokinesis hypothesis</i>	<i>Billie Ross</i>	44
	<i>Jack Houck</i>	47
<i>Electromagnetics hypothesis</i>	<i>Panos T. Pappas</i>	63
	<i>Richard Sparks</i>	64
	<i>George D. Hathaway</i>	67
	<i>Anonymous</i>	73
Canadian military perspective		75
The "Crystal Energy Converter"		78
Index		80



## John Kenneth Hutchison

- 1945 Born October 19 in Vancouver, Canada. Son of Kenneth and Margaret Hutchison.
- 1955 Early interest in electronics, chemistry, radio transmission and astronomy.
- 1959 First experiments in chemistry; fabrication of canons and guns.
- 1960 Formal schooling ends after grade 8 for a period of 3 years; lessons from private tutor in radio astronomy, physics and chemistry. Self-taught in physics, especially as related to Nikola Tesla's research.
- First laboratory, at home
- 1965 Electrical experiments using household circuit-outlet results in initial insights of energy production with Tesla-inspired technology.
- 1968 Production of three small *free energy* units with no input and resulting and output of 10 volts at 500 milliAmps.
- 1970 Onset of larger-sized Lynn Valley laboratory, located in North Vancouver. 13 tons of apparti include *gravity antennas*. Some personally developed set-ups are partly based on Tesla-inspired technology, along with one-of-a-kind test equipment acquired from army surplus supply.
- 1979 Breakthrough with *anti-gravity field* and disruption in metals -- levitation of objects, transmutation in metals. First material testing results of metal samples indicate that in the disruption process, the energy required to produce effects was at least one billion times greater than the 4,000 Watt input used. The results are known as the *Hutchison Effect* by the scientific community.
- Association with Alexis Pezarro, of Vancouver and George Hathaway, Toronto electrical engineer. Pharos Technologies Ltd. is founded. Partnership with Pharos lasts 6 years. Further development and control over *Hutchison Effect* is achieved.
- 1983 Start of U.S. Government interest. Demonstration of *Hutchison Effect* to U.S. Army Intelligence, and the Los Alamos Laboratory. Demonstration videotaped by these and other U.S. scientists. Metal samples taken for laboratory analysis. Test results were not released.
- 1984 Demonstration to Washington State University and Fort Worth Army Command, Texas.

Interviews by *BCTV News* and other TV stations.

- 1985 Demonstration to McDonnell Douglas Corporation's Jack Houck, in cooperation with Los Alamos laboratories and U.S. Army Intelligence.

Jack Houck introduces the question of psychokinetic component taking place in the *Hutchison Effect*.

Laboratory demonstration test results and video documentation of McDonnell Douglas Corporation (Department of Advance Systems and Technology) released.

*CKVU-TV Vancouver* news story.

- 1986 Canadian Scientific and Technical Intelligence Agency investigates *Hutchison Effect*.

Further testing, leading to greater mastery of effect.

North American and European laboratories indicate same results of atomic changes in samples.

700 demonstrations in 16 years.

1989 Invited by European scientists to Austria and Germany. During 2-year period, new discoveries in subatomic physics and in elimination of radioactivity.

Tour of California and New Mexico.

Worldwide offers of research partnership; rejects all offers.

- 1990 Return to Vancouver to find the laboratory destroyed by Canadian Government officials.

- 1991 Scientists offer to participate in psychotronic research and in development of anti-Gravity propulsion; no interest expressed.

Film documentary on UFO's with *Hutchison Effect* aired in 20 countries.

- 1992 *Hutchison Effect* published in *Raum und Zeit* [Space and Time], *Newsletter of the Planetary Association for Clean Energy*, *Electric Spacecraft Journal*, *Extraordinary Science*, and *Space Power*.

- 1993 *TV ASAHI* interview aired April 6, 1993 in Japan.

Japanese book about *Hutchison Effect* published by Nobuo Yokoyama, as part of Tokyo Free Energy Project.

Studies in theoretical physics of combining subatomic physics with space, time and energy.

Model of *Gravity Propulsion* developed.

March: Contract signed and partnership with International Energy, Kirkland, Washington.

1994 *Hutchison Converter*. Barium Titanate crystals resonating to extract 6 Watt continuous electric power output for about 6 months, until dismantled.

1995 Smaller-sized converter developed for Japanese tour, demonstrated in Hiroshima, before TV.

Newer "dirt cheap" version developed, utilizing selected rocks in chemical solution.

1996 Laboratory assembled with electric and electronic gear salvaged from Canadian Navy vessels.

## The Hutchison effect apparatus

by John Hutchison

reprinted with permission from the Electric Spacecraft Journal, Issue 9 (January-March, 1993), p. 21 - 28.

*There have been some serious investigations into the Hutchison Effect in Canada, the United States, and Germany. (See articles in ESJ #4.) The reality of objects being moved, levitated, or restructured by magnetic and electric field effects does not seem to be in question. Just how or why the events happen is the questionable part. John Hutchison has been providing ESJ with details on his work, as have a few others who have worked with him over the years. The picture consistently described is that of numerous experimental apparatus being operated simultaneously and interactively. "Events" occur, somewhat unpredictably. This is a format of accidental discovery through undefined mixture. It is exciting to the experimenter, yet frustrating to the scientist trying to sort out the interaction of the variables. Although recollection and details are difficult, Mr. Hutchison describes some of his apparatus in this attempt to share with other experimenters.*



John Hutchison—1985

I will attempt to explain details of the apparatus used in my experiments and will start with the input power used to trigger the host of Tesla coils, static generators, transformers, interferometers, magnetics, metal masses, and nuclear sources, etc. The source power was 110 volts AC operated at 400 watts to 4000 watts. One side of the AC line had a power factor capacitor (60 cycles, 250 volt), and a 100-amp current limiter. The magnetics of the current limiter were also used in the experiment interactions.

This power source was divided up in a function box and, through switching, went to variacs. The variac outputs were monitored by wattmeters, ammeters, and voltmeters, and supplied up to fourteen transformers. These included

twelve-volt transformers for vacuum tubes, 400,000-volt AC transformers, a Siemens 250,000-volt DC X-ray transformer, and other items. Regeneration equipment of 450 kHz up to 2500 MHz was also operated.

The general power circuit is shown in Figure 1. A and B are current limiters which ranged from two to seven amps. By this means some transformers were limited to this amperage instead of the fifty amps that might otherwise be drawn. The current limiters were adjustable and the magnetics from them were used in close proximity to the spark gaps and an alpha-beta emission unit. I had bypass switches on each current limiter which I used often. Unfortunately there was an incident one time in which

**Warning: The re-creation of certain aspects of these experiments is extremely dangerous and should not be attempted without proper training or guidance.**



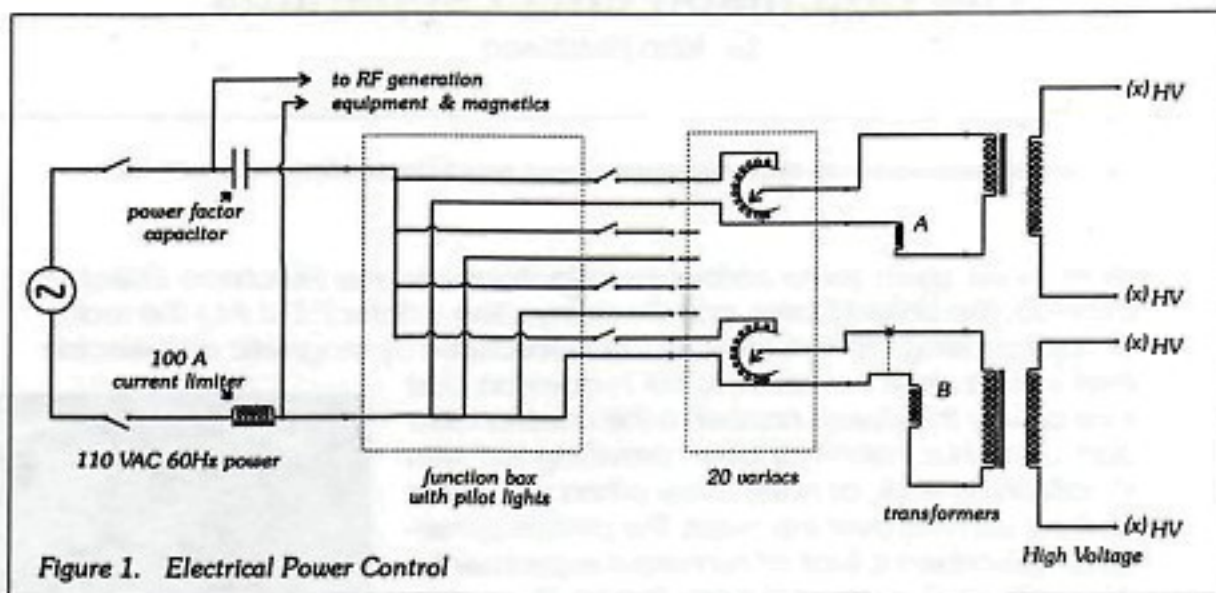

the outside pole transformer blew up when using the bypass switch.

The symbol (x) is used to represent the high potential leads in Figures 1, 5~7, 10, 12 and 17. These figures are rough schematics of some circuits.

My favorite Tesla coils are shown in Figures 2 and 3. Other Tesla coils I had were of the flat pancake-type with 1-inch copper tube in the primary and 10,000 turns of number 32 wire on an 8-inch diameter secondary tube. Another

coil used twelve-gauge wire on a 24-inch diameter tube, mounted horizontally. These are not shown.

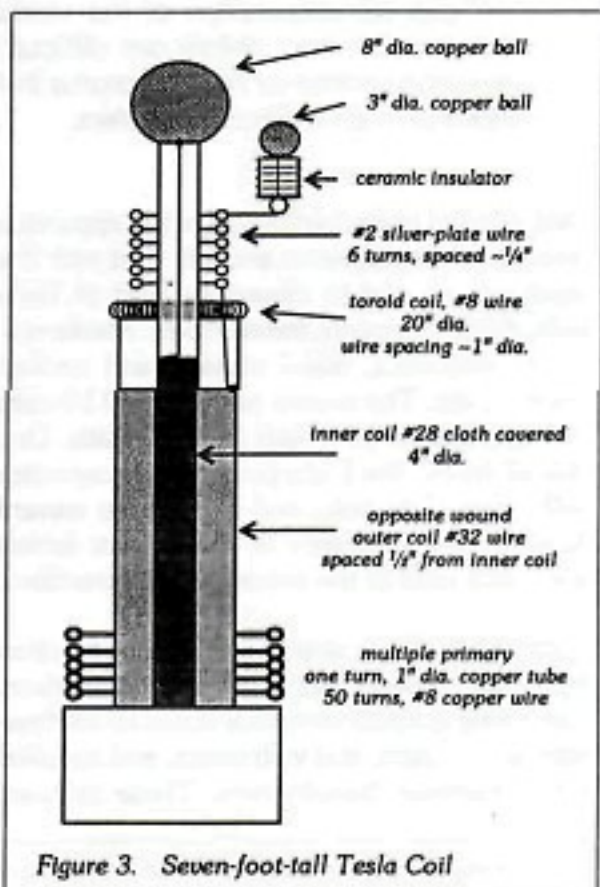
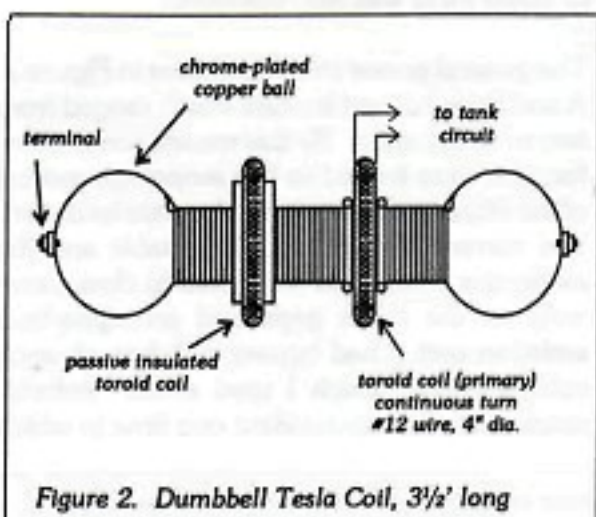

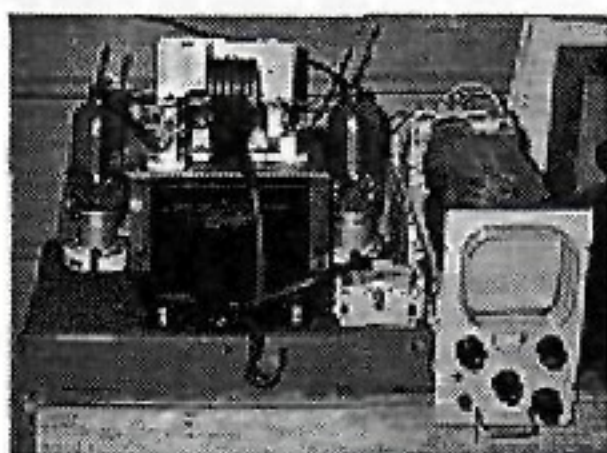

Figure 4. Vacuum Tube Tesla Coil Drive

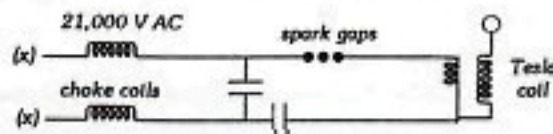

Figure 5. Tesla Coil A

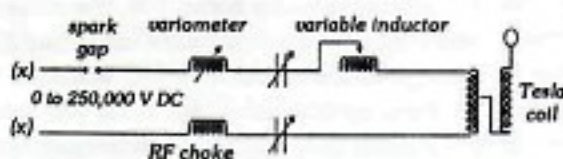

Figure 6. Tesla Coil B

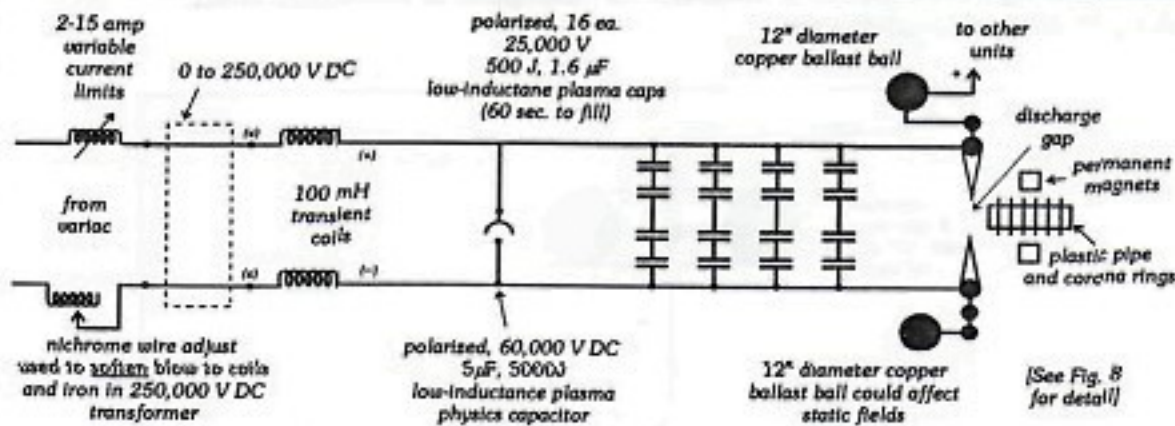

Figure 7. High-Voltage DC Insertion Pulse Unit

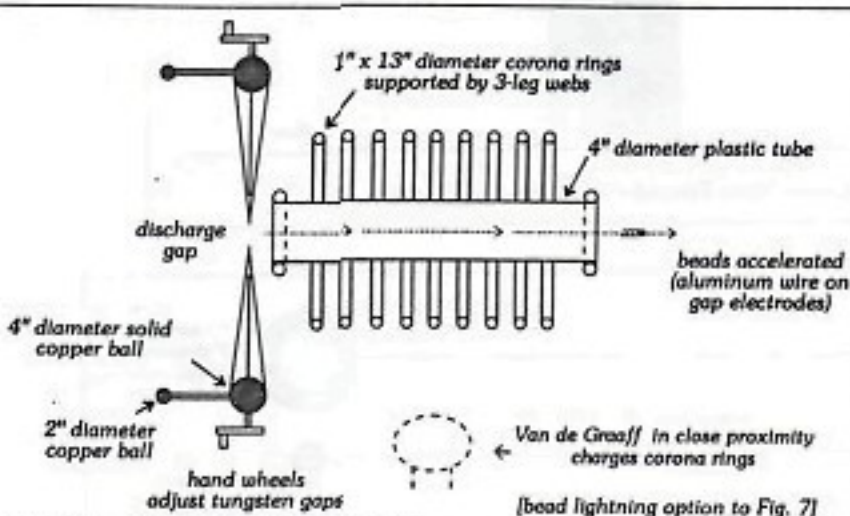

Figure 8. Ball Lightning Projector

The electronics of a vacuum tube Tesla coil are shown in Figure 4. Figures 5 and 6 show rough schematics of the Tesla coil circuits.

The schematic of Figure 7, powered by a high-voltage transformer, generated strong electric field pulses for a number of uses, including the projection of bead lightning, as illustrated in Figure 8.

One setup, illustrated in *Figure 9*, seemed to produce changes in the cosmic background radiation.

Some years ago, Drs. Lakken and Wilson argued over whether a "ball" of alpha-beta flux formed and deposited on the test samples. I personally don't believe so. I believe the alpha-beta flux was guided to the masses by being connected to high-voltage DC levels, by magnetic pulse fields, and excited by my mechanically-pulsed magnetron which excited the geometric metal. The idea is to excite the surface skin of the masses and their atoms to create an unstable space-time situation. This might allow the fields from the Tesla coils and RF generation equipment to lock up in a local space-time situation. My thought is that now a small amount of energy is released from the vast reservoir in space-time at the sub-atomic level to create a disruptive or movement effect.

If I increased the variac output to the Siemens transformer to increase the high-voltage DC on the large toroid, while keeping the rest of the laboratory system running, the Geiger counter would drop to near zero counts per minute within a 75-foot diameter zone. Yet, the reverse was possible (to increase counts) if I dropped the toroid voltage and increased all DC voltages to the laboratory system of Tesla coils (via tank circuits), RF coils, spark gaps, toroidal coils, and tension on the nuclear unit. The AC part of the laboratory system would be maintained at the same level. *Figure 10* shows a schematic of pulsing to the large main toroid.

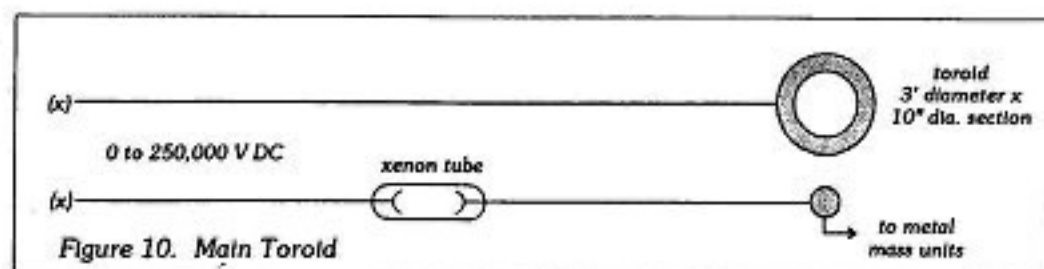
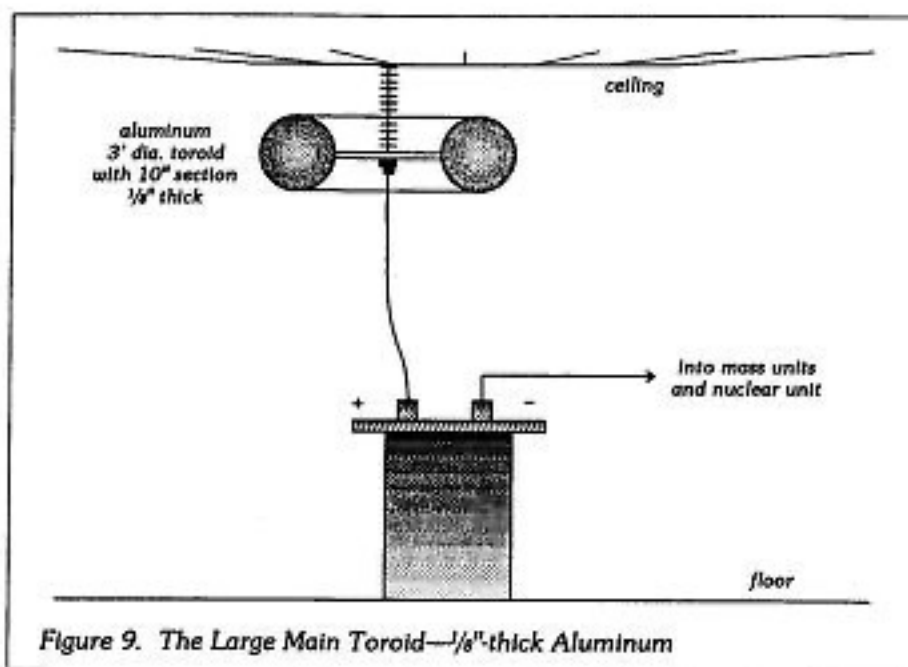
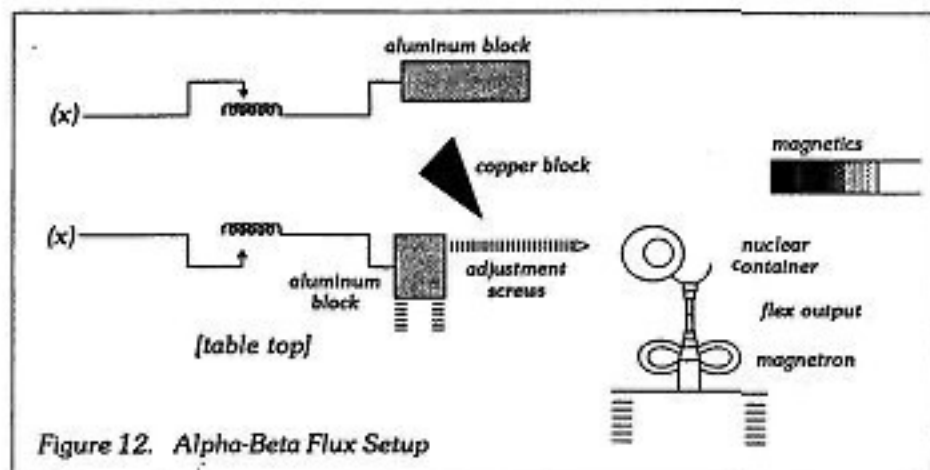
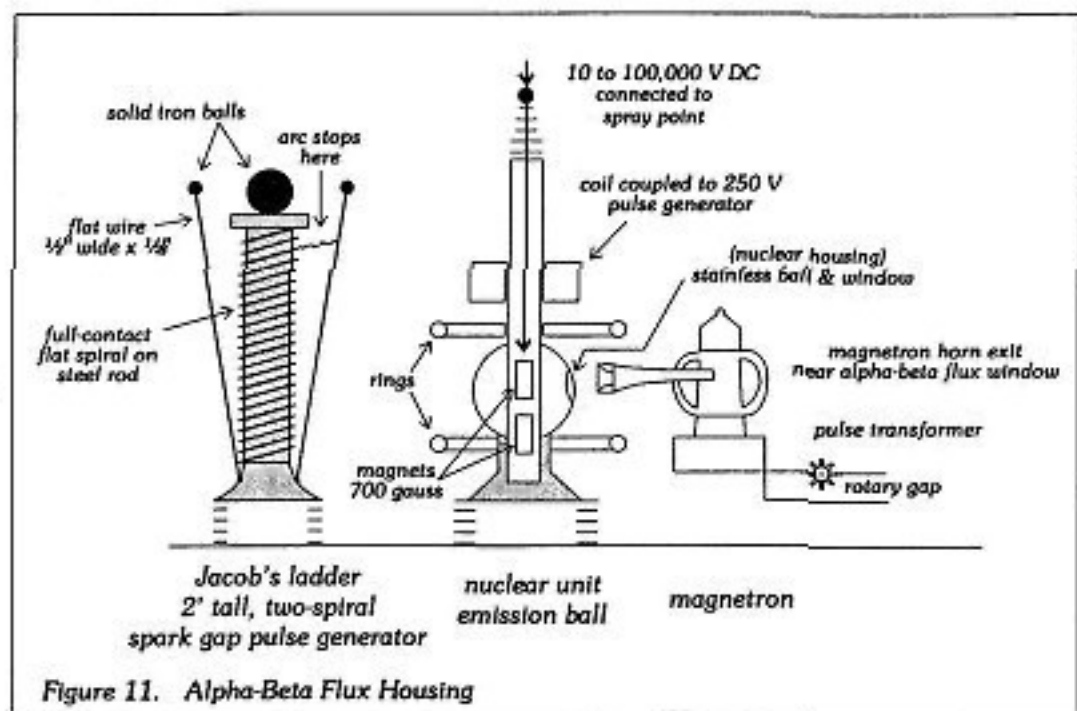



Figure 11 is a cutaway showing the nuclear section in the center of a Tesla coil. Note how I have the feed horn close to the window area. This area was also bathed in a 30,000-volt static electric field plus a weak magnetic field of only 700 gauss which was variable. A two-spiral spark gap unit is also shown in Figure 11.

The radioactive material to provide alpha-beta emissions was contained in a stainless steel ball which had a thin window section. A four-

gigahertz magnetron pulsed by an old rotary spark gap system sent microwaves by the window exit section. Small masses were placed close to the influence of the alpha-beta flux. The radioactive source was also under high-voltage DC and pulsed coils (50,000 to 100,000 turns) to produce traveling wave type magnetics and electrostatics to assist alpha-beta flux bunching and guidance. This all interacted with other surrounding equipment. Some additional arrangement is shown in Figure 12.



## Magnetics

A current limiter was used on "Big Red," a fifty-kVA, 89,000-volt transformer. A five-Hz spark-gap discharge went simply to a copper ground plate. The plate was movable and placement of the plate proved successful to later experiments.

My current limiter was made from 4" x 4" laminations stacked fifteen-inches high and number-eight wire wound six layers thick. The pulsing of the iron core proved its worth in tests. Its location was near the heart of my apparatus. Because it was a heavy unit, casters were needed to move it. The unit's pulse affected the electrostatics and Alpha flux, when close. The Alpha flux dropped off at two feet. Two other units in the setup were double-loop brass ship antennas five-feet high, as shown in Figure 13.

These are some basics of my laboratory. I excluded RF generation and coupling and all the radar-jamming devices I used later. I could precisely set up a pattern at 2000 mHz at 100 milliwatts. I could give or take ( $\pm$ ) 1000 mHz, add pulse rate, CW or modulation of any form.

Placement geometry is of great importance to key units of the electrostatic field and spark gaps. The electrostatic field must cover all components. Helping to do this are copper balls mounted on insulators. The large ball keeps its charge longer while small ones discharge faster. In a way, you have a pulse network working along with dynamic electricity, and the small influence of the 250-milliwatt magnetron close to the alpha-beta flux. In the zone is weak magnetics, permanent

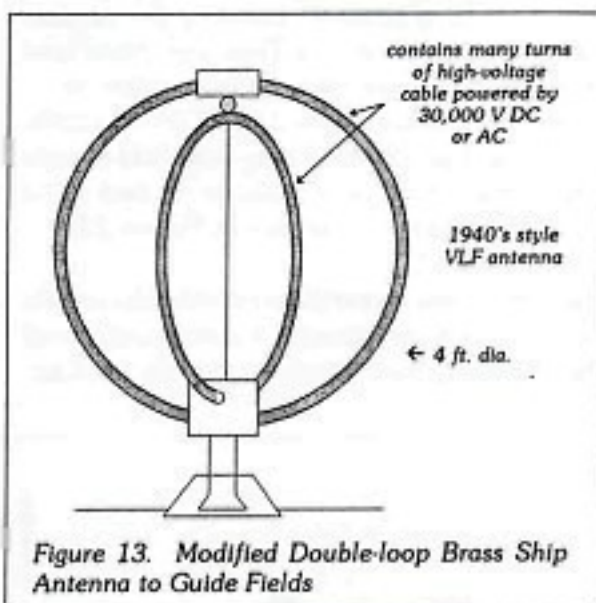

Figure 13. Modified Double-loop Brass Ship Antenna to Guide Fields

magnets, and electromagnets of the traveling wave tube (TWT) barrel types. Thus, perhaps a transformation takes place on the subatomic level in all of this, and a conversion zone takes form from the surrounding equipment. This zone seems to transform again to zones beyond the lab, up to 500 feet away, in the form of a cylinder. There appeared to be a zone at a distance of fifteen feet. Samples placed in it sometimes levitated or broke apart.



Figure 14. Hutchison's Setup of Receivers and Monitors

### Sample Reactions (Extracted from Reports)

The effects of unexpected field interactions are shown in *Figures 15 and 16*. One sample, a piece of aluminum four-inches long by 1/2-inch square, had been shattered in the center. It would be expected that only a few watts were in this zone, compared to the 4000-watt input feeding all the equipment. Our sample had exploded from inside out, torn into thousands of filaments. The filaments measured .010" to 0.50" long and .008" to .012" thick. The event volume expanded outward from the mass center in seeming reaction to a force of mutual repulsion between filaments.

The field lines picturesquely frozen in the aluminum filaments are functionally identical to those we observed at a point of fracture of a permanent bar magnet of the same geometry. The force exerted on the aluminum filaments was sufficient to split a large number of the outermost strands and fold them back along the "field lines" to such a degree that layers of them are compacted together, against the solid surfaces of the sample.

The material within the event volume was much harder and quite brittle compared to the original extrusion alloy, which was quite soft. All surfaces evidenced a mottled appearance and regular



*Figure 16. Solid Metal Bars Split and Frayed by the Hutchison Effect. (Max Planck Inst. Photo.)*

structure, while having none of the characteristics associated with plastic deformation or melting. Physical characteristics were typical of crystalline materials sheared along bonding planes. The number of filaments probably exceeded 100,000, effectively increasing the surface area within the event by tens of thousands of times.

Another sample showed inexplicable material mixtures: wood was found in an aluminum block tested by Siemens Laboratory, Germany. Also, dense, impossible alloys of elements forming unknown materials were found by work of Max Planck Institute, Germany. Because so many different effects happen, including levitation, we can speculate the RF and support field operators are working in a narrow region of the "zone of effects." These random events sometimes happened at about five-per-hour in 1987, '88, and '89.

It is an unpredictable probability for all operators to synchronously combine to cause an effect. For events like slow lift and slow disruption, the operators combine under simple stable outputs, amplitudes, and frequency. Our space-time window would have to be described on the subatomic level for the understanding of the Hutchison Effects.



*Figure 15. Aluminum and Brass Bars After the Effect*



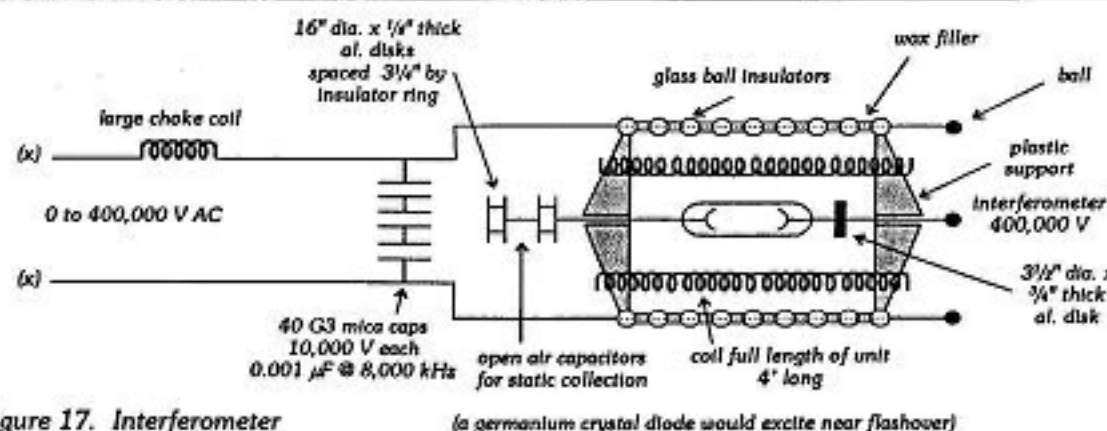

Figure 17. Interferometer

(a germanium crystal diode would excite near flashover)

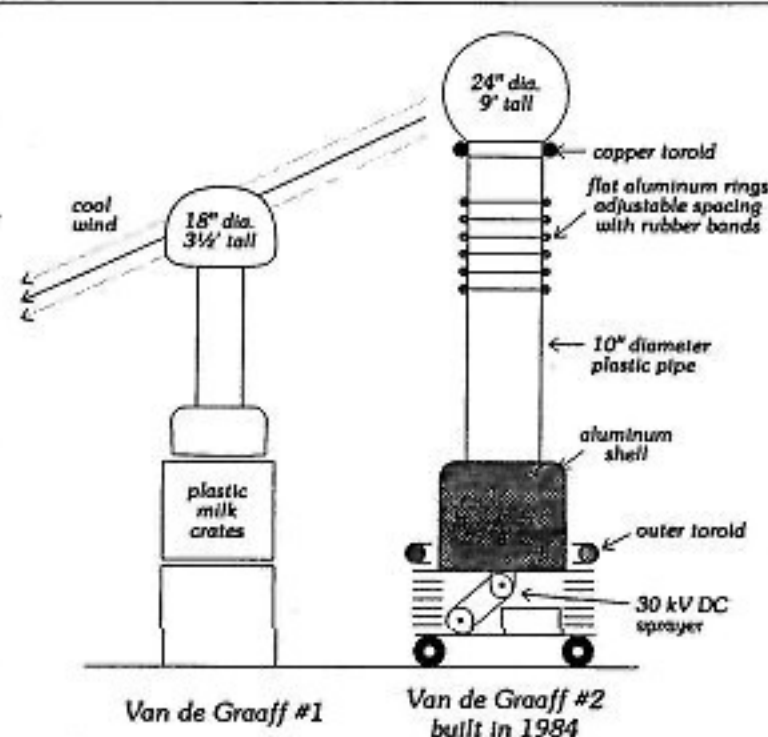

Figure 18

### Acknowledgments

I would like to thank those individuals associated with Pharos Technology, the Max Planck Institute, Los Alamos, McDonnell Douglas, BAM Labs Germany, Fraunhofer, the Austrian and German groups, the DOD groups, and individual input from Japan, Greece, England, Canada, USA, Switzerland, France and the Yin Gazda International Filmmaker, for the interest and support they all have shown.

### About the Author

John Hutchison is the classic independent individual experimenter—a self-made physicist. Mr. Hutchison can

be reached by mail at 731 5th Avenue, Apt. 306, New Westminster, British Columbia, Canada, V3M 1X8. ★

Figure 17 is another pulsing circuit device I call the interferometer. Electrostatics were produced with two Van de Graaff generators. When arranged as shown in Figure 18, cool wind effects could be produced. These machines were used to impose an electrostatic field in the test area.

# The Hutchison effect - a lift and disruption system

George D. Hathaway

reprinted from: New Energy Technology, published by the Planetary Association for Clean Energy, 1990. p. 77-103.

The following may shed light on a most unusual phenomenon which we have called the "Hutchison Effect". It is a very strange arrangement of technologies including those of Nikola Tesla and Robert Van de Graaf. This is a topic that is very conducive to wandering because it brings in all of the most amazing kinds of effects that one would love to have in their basement, such as material levitating and floating around, being able to break steel bars without the use of your bare hands, and all sorts of other weird and wonderful things.

Pharos Technologies Ltd. was a company formed by myself and a gentleman by the name of Alex Pezarro, who you may recall made a presentation at the 1983 2nd International Symposium on Non-Conventional Energy Technology in Atlanta. Alex talked about one of his pet projects, which was oil and gas discovery by novel means. In 1980, we formed this small company to try to promote what we then called the Hutchison Effect. We also termed it in our early presentations: LADS or the Lift and Disruption System. The following series of graphs were created in 1984 to present to various parties interested in funding this technology. The first graph indicates the topics covered in these presentations.

## I A INTRODUCTION + HISTORY

L.A.D.S. IS CAPABLE OF :

- INDUCING LIFT AND TRANSLATION IN BODIES OF ANY MATERIAL
  - SEVERELY DISRUPTING MOLECULAR BONDS IN ANY MATERIAL RESULTING IN CATASTROPHIC DISRUPTIVE FRACTURING
  - CAUSING CONTROLLED PLASTIC DEFORMATION IN METALS
  - CREATING UNUSUAL AURORA-LIKE LIGHTING EFFECTS IN MID-AIR
  - INDUCING APPARENT LARGE-SCALE MAGNETIC MONOPOLES IN METALS
  - CAUSING CHANGES IN CHEMICAL COMPOSITION OF METALS
  - OTHER LONG-RANGE EFFECTS
- } PROPULSIVE
- } ENERGETIC

ALL AT LOW POWER AND AT A DISTANCE !

The Lift and Disruption System or the Hutchison Effect is divided primarily into two categories of phenomena: propulsive and energetic. The system is capable of inducing lift and translation in bodies of any material. That means it will propel bodies upwards, and it will also move them sideways. There are actually 4 kinds of trajectories which are capable of being produced and I'll explain these shortly. It also has very strange energetic properties including severely disrupting inter-molecular bonds in any material resulting in catastrophic and disruptive fracturing, samples of which are described here. It is also capable of causing controlled plastic deformation in metals, creating unusual aurora-like lighting effects in mid-air, causing changes in chemical composition of metals (it varies the distribution of the chemical content), and other long-range effects at distances up to around 80 feet (24 metres) away from the central core of the apparatus -- all at low power and at a distance.

I INTRODUCTION + HISTORY

- UNPRECEDENTED ACTIVITY FROM A SINGLE SYSTEM
- TRUE SYSTEM WITH MANY INTERRELATED PARTS
- DEVELOPED TOTALLY FORTUITOUSLY FROM EXPERIMENTATION WITH EARLY A.C. AND STATIC MACHINES
- BASED ON IDEA OF INDUCING "SWIRL" OR ROTATION IN EM. FIELDS
- EARLY EVIDENCE OF POWER OF L.A.D.S.
- PHASE 0 DEVELOPMENT OF PROGRAM BY PHAROS TECHNOLOGIES Ltd.
- UNPREDICTABILITY OF L.A.D.S. IN EARLY TRIALS
- RE-ESTABLISHMENT OF L.A.D.S. LAB UNDER PHASE 1 PROGRAM
- SUCCESS AT RE-CONSTRUCTING L.A.D.S. IN NEW ENVIRONMENT

II VISUAL EVIDENCE - FILM + STILLS

- OVERVIEW OF CROWDED, PRIMITIVE ORIGINAL LAB
- STATE OF ORIGINAL SET-UP:
  - POOR CONNECTIONS
  - HAND-WOUND COILS ETC.
  - LACK OF INSTRUMENTATION
- DIFFERENCE BETWEEN ORIGINAL AND LATEST LABORATORIES
- BASEMENT OF HOUSE - L.A.D.S. DRAWS MAXIMUM OF 1.5 kw. FROM HOUSE MAINS
- BEST LIFT EPISODES IN EARLY BASEMENT LAB
- POOR PHOTOGRAPHIC RECORD IN EARLIEST TRIALS
- HIGHLIGHT - BURNOUT OF ARMATURE + FIELD COILS OF SABRE SAW
- MANY MATERIALS CAPABLE OF BEING SELECTIVELY INFLUENCED
- INDEPENDENT, QUALIFIED WITNESSES.

The system is a single entity, made up of many discrete components. It has many interrelated parts, unfortunately continually being added to by the inventor. It was discovered fortuitously by Hutchison, who was experimenting with early Tesla systems and static machines such as Van de Graaf generators.

The earliest explanation was given by Mel Winfield of Vancouver, whose name may be familiar from Dr. Nieper's 1988 Congress in Germany. He suggested that the explanation for the phenomena was due to a method of making the electro-magnetic fields spin or swirl in some unknown way.

Pharos Technologies was involved in three phases of development, the first phase of which was in the basement of a house in Vancouver. This is where John Hutchison's original work was done. The collection of apparatus which will boggle the mind can be seen on the video (shown during the lecture and available from the publisher) and replicated in Figures 11 and 12. That was the Phase 0 development. Phase I was when we stepped in with some money and took the equipment from the original location and put it in a more reasonable setting. Phase II was a third location prior to its being dismantled and put into storage by John.

The main thing about this technology, apart from its unusual phenomenology, is that it is highly transitory. The phenomena come and go virtually as they please. One has to sit with this apparatus from between six hours and six days before one actually sees something occurring. This makes it virtually impossible to interest someone who would like to try to develop it, to assist in funding, for instance. You can't assume that someone will sit there who is ready to help develop a technology, and have him wait and wait, and perhaps nothing will happen. It's unusual to ask someone to wait six days for a phenomena that they're interested in developing commercially. So one can imagine that we've had some difficulty in the past in financing this program.

Note in Figure 11 one of the Tesla coils in the foreground. The main coil is 4 1/2 feet (1.4 m) high. It was extremely difficult to get around in the first lab (Phase 0). The first laboratory in Vancouver was so densely packed with equipment that you could not find a place to put your foot down. You had to step around all sorts of objects that were put on the floor.

### Disruptive phenomena

In the video a bushing is shown breaking up. It was a steel bushing about 2 inches (5 cm) in diameter by 3 to 4 inches (9 cm) long. John still has that in his lab and I have some to show as well (Figures 1 and 2) .

The next part of the video is well known. I will try to explain some of its phenomenology. It starts with John warming up the system. To determine where the optimum place for positioning the test objects, which will either take off or burst, he put coins and bits of styrofoam where he believes is going to be the active zone. The first thing that happens is a quarter (\$.25 coin) starts to flip and vibrate. Now he knows he should concentrate putting specimens in that zone and he does so. We see some water in a coffee cup that appears

---



to be swirling, although it's not. It is merely the surface rippling by some electro-magnetic means and the coffee cup is dancing around the top of a yellow milk carton. It's another way for him to determine where the zone is. Then we see a flat file 8 inches (20 cm) long breaking apart. This file broke into four more or less equal-length sections. Normally, if you break a bar magnet, you know that you break it north-south, north-south, north-south, etc.. So the parts tend to stick back together again. In this case the segments were magnetized the wrong way by some phenomena I do not know and they repel each other when they're put together at the breaks. This may be indicative of the development of large-scale monopolar regions that are of such intensity that they disrupt the material itself. It's as reasonable an explanation as I've been able to come up with, or anyone else.

### Lifting phenomena

We then proceed to document some lifting phenomena. The objects that are lifted in the first part of this section are on the order of a few pounds. All of them lift off with a twist. They spiral as they lift off. There has to be a particular geometry with respect to down (gravity) for them to take off. Some objects, if you lie them on their sides, won't take off. If you turn them on their ends, they will take off. The geometrical form of the objects, their composition and their relationship to their environment, the field structure around them that is being created by the device, all play a part in how these things take off.

There are four main modes of trajectory that these objects can follow if they do choose to take off. There's a slow looping arc where the objects will basically take off very slowly in a matter of a couple of seconds and loop and fall back somewhere else. It is almost as if the Earth moves underneath them while they are in flight, and they fall back in different locations. The second type of trajectory is a ballistic take-off. In other words, there's an impulse of energy at the beginning of the trajectory with no further power applied to the lifting thereafter, and the object hits the ceiling and comes back down. A third type of trajectory is a powered one where there appears to be continuous application of lifting force. I have some evidence taken from the video. The fourth trajectory is hovering - where objects just rise up and sit there. The objects can be of any material whatsoever: sheet metal, wood, styrofoam, lead, copper, zinc, amalgams and they all either take off or they burst apart, or they do nothing -- that's 99% of the time.

### Lighting phenomena

Following that is a strange lighting phenomenon. This only occurred once but fortunately, while John was filming. Incidentally, this early film, with the most spectacular results observed, was taken by John himself. It was taken in 1981 and all of a sudden a sheet of iridescence descended between the camera and some of the apparatus and one sees that sheet of light. It has a strange pinkish centre to it and hovered there for a while, and then disappeared. John thought he was hallucinating,

---

---

but when we developed the film it turned out something was definitely there.

In this same video, we observe heavier objects taking off, including a 19-pound (8.6 kg) bronze bushing and water in a cup that's dancing around, the surface of which is vibrating. There are no ultrasonic or sonic devices in this particular series of experiments. There are no magnetic components underneath or over top. There are no field coils underneath or over top or anywhere within 6 feet (1.8 m). These images were taken while the apparatus was performing at peak, and shows best results for the earliest experiments.

Sometimes, instead of lifting objects, John will purposely try to destroy them. In one case, a 1/4" round rattail file rests on a plywood base and is held down from taking off by two plywood pieces. Beside it are some quarter and penny coins. The file is glowing white hot and yet there is no scorching of the wooden plywood pieces which are holding it down. Neither are any of the coins affected. This is explainable in terms of RF heating theory because you can have eddy current heating on the surface and it's almost cool to the touch very shortly thereafter. It's still unusual that there is no conductive heat transferred to the wood.

From time to time there are scorch marks on the boards from other experiments. The apparatus makes fire spontaneously in parts of the lab if you're not careful.

The original (Phase 0) lab set-up was primitive, crowded, had poor connections, and had hand-wound coils. However, the films that have most of the best lift episodes were done in this early set-up, drawing a maximum of 1.5 kilowatts continuously from house-mains.

### Disruption effects

#### - A WEALTH OF CONFIRMATORY PHYSICAL SAMPLES

- INCLUDING :
- WATER
  - ALUMINUM
  - IRON, STEEL
  - MOLYBDENUM STEEL
  - WOOD
  - COPPER, BRONZE
  - \* COMBINATIONS OF ABOVE

- ALL SHAPES, SIZES, AND MASSES

- CERTAIN MATERIALS SUBJECT TO CERTAIN INFLUENCES PREFERENTIALLY

#### RESULTS OF PHYSICAL, CHEMICAL AND ENERGETIC ANALYSES

##### - B.C. INSTITUTE OF TECHNOLOGY :

- HARDNESS
- BRITTLENESS & DUCTILITY
- OPTICAL MICROSCOPY

##### - B.C. HYDRO R/D LABORATORY :

- SCANNING ELECTRON MICROSCOPY
- ENERGY DISPERSIVE ANALYSIS

##### - U. of TORONTO DEPARTMENT OF METALLURGY :

- SCANNING ELECTRON MICROSCOPY
- ENERGY DISPERSIVE ANALYSIS (X-RAY)

##### - LOS ALAMOS TESTS

The disruption part of this Lift and Disruption System has produced confirmatory physical samples that include water, aluminum, iron, steel, molybdenum, wood, copper, bronze, etc., with many shapes, sizes and masses. Certain materials are subject to certain influences depending on shape, composition and other factors.

We have tested various pieces that have broken apart for hardness, ductility, etc.. We have used optical and electron microscopes. We have taken SEM's with EDA's (Energy Dispersive Analysis) to determine the composition at various points.

Two samples of aluminum are shown, one of which is in the centre of Figure 1, which is twisted up in a left-handed spiral, and in Figure 2 on the left which was blown into little fibers. Lying on the ruler in Figure 1 to the left of centre is a molybdenum rod used in nuclear reactors. These things are supposed to withstand temperatures of about 5,000 °F. We watched these things wiggle back and forth, and stopped the apparatus halfway through a wiggle and that's the result. Figure 2 (left) shows the piece of cast aluminum that burst apart.

In general, Figure 1 shows a collection of pieces of metal that have been blasted apart or twisted. The largest piece (in the background) is about 12 to 13 inches long. It's two inches in diameter, of regular mild steel, and a 3/8 of an inch long part was blasted off the end and crumbled like a cookie. Fragments have been analyzed to have anomalously high silicon content although the original material was not a silicon steel. The standing piece on the left is 5 - 6 inches tall, 1 and 1/4 inches in diameter. It is a piece of case-hardened steel. The case-hardening has been blown off at the top and about 3/4" of it vapourized during an experiment. Then there are various pieces of aluminum and steel. On the right of Figure 2 is a boring bar. You can still see the old tool bit that John was using through it. It was on a shelf about 10 feet away from the centre of the apparatus and he did not see it happen. It just bent up into a tight U and deposited a quantity of copper at the bend. The copper seemed to somehow magically come out of the solid solution, if it was ever in solution in the first place, and agglomerate as globs at the break. As far as the aluminum is concerned, it's a volume effect, not merely an eddy-current surface effect. The whole thing is blasted right through.

Figures 3 to 6 show some of the scanning electron microscope photos taken by the University of Toronto. Figure 3 shows an aluminum specimen at about 70 times magnification and the whole surface is torn apart, as if it was gouged randomly by some mechanical means. It has not been smoothed and polished and subject to x-ray or dispersion analysis yet. A piece of iron is shown in Figure 4, and was analyzed for composition which showed anomalously high amounts of copper.

With a little higher magnification for Figures 7 and 8, we see what happens in a polished aluminum sample under the SEM. Figure 7 shows two main horizontal fracture zones.

---

This is a polished sample, that is why it looks nice and clean. Notice the unusual globules forming (positions B & C). We examined these particular globules and they're virtually pure elements. One is copper, another is manganese and others are different elements. These globules seem to arrange themselves along planes and these planes are no doubt the ones that split apart and delaminate into fibers.

Figures 9 and 10 show the relative elemental abundances of locations H and D of Figures 7 and 8. Normally, the aluminum comes out looking like Figure 9. The average is mostly aluminum, of course, but with a bit of copper in it. And yet (Figure 10) shows an area around where the fractures occur and we see we have actually located one of the copper blobs, plus some chlorine from our fingers. Usually you see some chlorine and sodium from salt in your hands if you're touching samples. It's certainly telling us that something unusual is happening. I have not seen another apparatus which makes the alloying material in an alloy come out of the solid solution. Usually it's totally dispersed in the melt but in this case we're "undispersing" it somehow.

The Pharos experimental set-up for the Hutchison effect

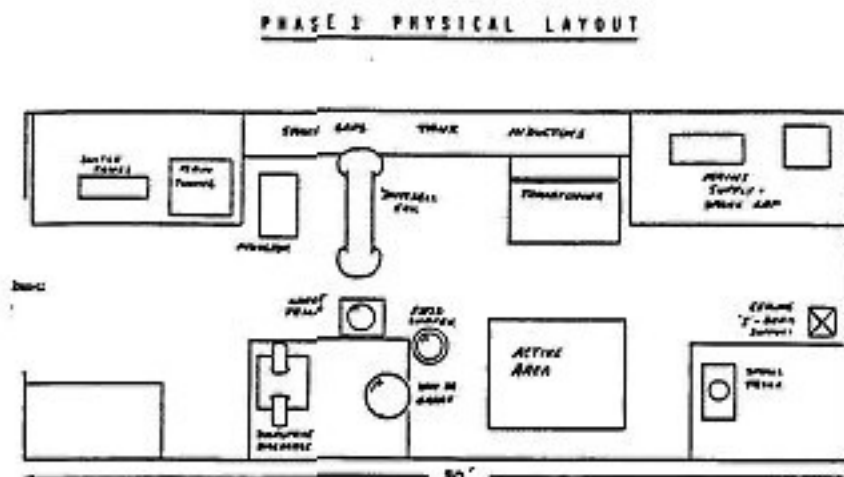

This plan view shows the first (1983) set-up under Pharos' control.



The field-shaping unit is basically an elevated aluminum sphere about 11 inches in diameter. The essential ingredients of the power supply are two 15 kilovolt neon transformers. Large steel masses were all over the place. In his first and most effective experiments, John had a 400 kilohertz continuous wave generator instead of the small Tesla coil. It's basically a low frequency radio transmitter that he had switched on for the operation, and it had a 3-foot whip antenna. Later he replaced that, likely because it broke, with the small Tesla coil, which is about three feet off the ground and is about 1 1/2 feet high.

This lab was set up to try to attract some more funding and I personally put it together, trying to pick the essential bits of the apparatus out and assemble them myself. That is the lab from which a number of these samples came.

Spark gaps and tank circuits line one wall. There's a 21 kilovolt transformer in front of the inductors from a Picker X-ray machine which powers a number of these spark gaps. The gaps fire at 60 cycle rep rate. There is a double-ended "dumbbell" Tesla coil suspended from the ceiling. The large Tesla coil, the field-shaper, Van de Graaf generator, and a Tesla disruptive discharge coil are also shown. This latter is a double-ended, iron-core transformer. The distance is approximately 12 feet between the large Tesla coil and the small Tesla coil. Between them is what is called the active area, and that is basically a platform on which we put objects of whatever material we wish, and hope that they'll leap to the ceiling or burst apart. The main tuning control consists of several high-voltage variable capacitors and various inductors.

Figure 11 shows the lab that I set up in 1983. I admit it is rather messy. I tried to set it up exactly as John had set it up, and so I did not make nice connections, etc.. I wanted it to be just the same as what he had done, except I tried to use a minimum number of components. The large Tesla coil is 4 1/2 feet tall (secondary), a few thousand windings of number 27 or 30 enameled. It has a toroidal coil of about 12 gauge resting near its top. The Van de Graaf is about 250,000 volts DC maximum. It has an approximately 11 to 13 inch diameter ball. Also visible are various tuning capacitors. You can see high voltage transmitting caps of very large capacity and RF coils here and there. Overhead is the double-ended "dumbbell" Tesla coil with its electrodes with the double toroid primary. Down below, out of sight, is a spark gap that snaps every 40 seconds or so, and in the back corner is the small Tesla coil. It's a double 807 triode Tesla coil which has a nice spot frequency of about 760 kilohertz. The large Tesla coil, when powered normally, resonates at somewhere around 330 kilohertz.

Figure 12 shows another photo of a later set-up (Phase 2) in early 1987, where several unusual phenomena were filmed by a television crew and was shown on the national news. This was John's lab before he tore it apart. It is shown merely to suggest the size and scale of the devices.

---

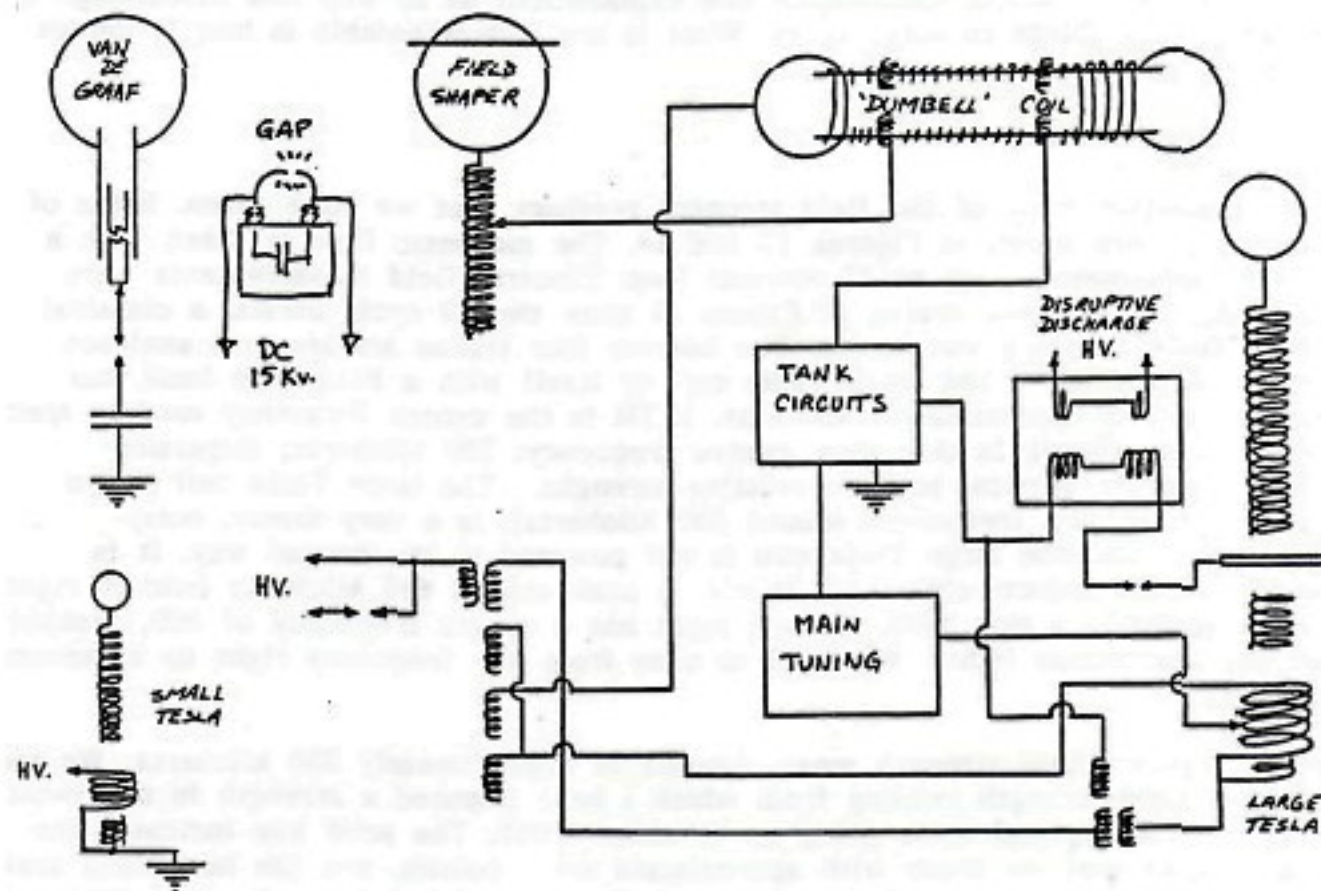
BLOCK CIRCUIT DIAGRAM

The general block diagram shows the Van de Graaf by itself on the left and it goes through a gap and a capacitor. The gap is never firing to ground! The small Tesla coil is shown underneath. It is a little experimental Tesla coil powered all by itself (dual 807 tubes). All components are powered from a single 15 Amp, 110 volt, 60 Hz supply. The main spark gap shown by itself is about 3/8" wide which is powered by a 15 kilovolt DC supply across a capacitor. It snaps every 40 seconds or so and causes a great blast. There is no time correspondence between the snapping of that gap and objects taking off or dismembering themselves.

Neither John nor I know the specific function of any of this apparatus in producing these phenomena, and one of the primary reasons for this presentation is to foster collective investigation leading an understanding of what is going on. I do not know the mechanism whereby this assemblage of components causes objects to lift. I can come to some reasonable conclusions and explanations as to why this assemblage of apparatus causes things to burst apart. What is not understandable is how it causes objects to lift.

### Field strength readings

I should mention some of the field strength readings that we have taken. Some of these results are shown in Figures 13 and 14. The magnetic field is taken with a strength field meter using an 8" vertical loop. Electric field measurements were also made. The top two traces of Figure 13 show the 60 cycle bursts, a classical kind of Tesla decaying waveforms. The bottom four traces are spectral analyses. The middle left shows the small Tesla coil by itself with a little side band, but its main peak is approximately 760 Khz. (CTR is the centre frequency used in spectrum analysis terminology). In this case, centre frequency: 760 kilohertz; dispersion: 10 KHz, and the vertical scale is relative strength. The large Tesla coil shown bottom left, (centre frequency: around 350 kilohertz), is a very messy, noisy spectrum because the large Tesla coil is not powered in the normal way. It is powered merely inductively. There is also a peak around 610 kilohertz (middle right) which is probably a side band. Bottom right has a centre frequency of 300, probably from the fluorescent lights. We tried to scan from low frequency right up to several megahertz.

Figure 14 shows field strength measurements at approximately 350 kilohertz. We took a relative field strength reading from which I have imputed a strength in microvolts per metre, the vertical scale going up to about 7,000. The solid line indicates the measurements that we made with approximate error bounds, and the horizontal scale is in feet from the centre of the apparatus. The dotted line is an inverse square line just for reference. There is nothing very unusual here.

**Tom Valone (Buffalo, New York):** Are you actually telling us that you only have 2,000 microvolts per metre as the peak ? Its amazing, I expected at least kilovolts per metre.

**George Hathaway:** The maximum, if we extrapolate that curve is about 100K microvolts per metre right in the centre of the active area. I should caution: this measurement was taken when the apparatus was not working to full potential. Whether, when major events happen, the field strength goes way up, I'm not sure. This was a normal run where some slight movement was happening to make sure the apparatus was functioning, but nothing major was occurring.

---



Tom Valone: When you say the field strength may go way up, how far do you mean?

George Hathaway: I have no idea. We were not able to have the field strength meter at the time as the best lifting was taking place or disruption was taking place. Therefore, I cannot tell you what the electrical field strength would be when the major phenomenon was occurring. I could only imagine based on engineering principles that it would be much higher than 0.1 volts/metre. Don't forget this is only the AC portion of the field.

Something I have a little more control over is an analysis of the lifting capability. Figure 15 shows a strip of the 8 mm film of that 19-pound bronze bushing taking off in slow motion. This is what I consider the powered take-off and its confirmed by the measurements. I measured the distance between the bottom end in its resting position and the bottom end when it actually leaves the frame and plotted that.

Marcel Vogel (San Jose, California): Look at the right-hand side at the series of patterns that you are seeing there. (Figure 15)

George Hathaway: That's the pattern of the milk carton on which this sample is sitting.

Marcel Vogel: Is it a milk carton or is it a reflection from that surface?

George Hathaway: That's a milk carton. If you wish me to run the video again with this particular segment, I will and you can confirm that.

Marcel Vogel: If it was a beat wave you would have a very valuable bit of information.

George Hathaway: That's true. We also have another valuable bit of information in the length of the breaks of the file. That gives us an indication of the wavelength of impinging fields, but nowhere near the kinds of frequency that I would expect to be required to do any of this. But that's a good point. One should always analyze the spatial distribution of how things break for the clues as to the range of operating frequencies.

Now if we plot this take-off and derive an acceleration versus time graph we get Figure 16. I do not have my error analysis so I can't give you a standard deviation on some of these points, but the result is that there is a linearly-rising acceleration curve. There is increasing power being provided to the object as it lifts ! It's a 19 pound bushing !

---

Increasing propulsive power is being applied to this as witnessed by this increasing acceleration curve. These are the actual measurements to about 0.16 seconds and beyond is an extrapolation. The -9.1 in the acceleration equation is merely an artifact of my measuring problem, analyzing that film strip. Keep in mind, this means that when it hits the ceiling, this 19 lb. bushing is traveling at 20 m/sec. (45 mph, 72 kmh) and increasing!

I am at sea in trying to determine how the device can provide a lift. In this "Theoretical background" listing, I mention a few names that might have something to do with an explanation of it.

DISCUSSION OF CURRENT & EARLY THEORIES IN

CLASSICAL & QUANTUM PHYSICS

ENERGETIC EFFECTS

- G. LeBON
- VALLEE
- BOYER
- PRIGOGINE

PROPULSIVE EFFECTS

- HOOPER
- HOLT
- GRAHAM & LAHOZ
- ZINSSER/PESCHKA

PLUS MANY OTHERS NOT MENTIONED HERE

Finally here is a listing of a few potential applications of this effect if it can be produced in such a format that it is repeatable and controllable: rocket payload assist, materials handling and warehousing, floating things into position, materials handling of hot objects, objects that are highly radioactive or dangerous, forging and casting, extruding of metals, alloying, power production, conversion, etc., and defence applications.

In conclusion, this is an extremely difficult technology to wrap one's mind around. I have had a great deal of difficulty in convincing scientists to think about this possibility, let alone try to provide some mechanisms for understanding its operation.

---

A P P L I C A T I O N S

- PROPULSIVE : - MICRO-GRAVITY ENVIRONMENTS ON EARTH  
- ROCKET PAYLOAD BOOST ASSIST  
- MATERIALS HANDLING & WHAREHOUSING
- ENERGETIC : - FORGING, CASTING, EXTRUDING OF METALS  
- ALLOYING  
- POWER PRODUCTION, CONVERSION & TRANSMISSION
- OTHER : - DEFENSE APPLICATIONS
- ETC. ETC. ETC.

I hope I'll be able to engender some interest so that people will think about it. Perhaps some will, if they have some equipment, do some experiments as well.

I must caution anyone who is pursuing this that it is an extremely dangerous apparatus. It has never knocked any of my fillings out, but it certainly has a potential for doing so. It has smashed mirrors, in one of its incarnations, 80 feet away. It has overturned a large metal object about 50 or 60 pounds about 100 feet away. And its effects can't be pinpointed unless we're lucky. We try to find the active area and then we hope that something will happen but perhaps something very far away will happen. The apparatus is capable of starting fires anywhere. It will start fires in concrete, little bursts of flame here and there and it will cause your main circuits to have problems. We've blown fuses out as well as circuit-breakers and large lights.

---

It also tends to destroy itself and a classic case of that is when we had some important potential investors looking to help develop it. In the morning of its being shown, it blew one of its own transformers apart, and so, needless to say, we could not do a successful demonstration.

**Marcel Vogel:** Congratulations. I find it exceedingly exciting and interesting. I too have experienced the generation of power like this with a crystal. Just a single, natural quartz crystal cut in a special form. I generated fields which have knocked out electrical equipment and generated power which has destroyed matter. My suggestion to you is to do specific gravity measurements on the pieces of metal on the beginning and end of the specimen. What I think is happening is that there is inter-vibrational activity going on; namely, you're stimulating the lattice motion, and when it gets to a critical space, the lattice collapse and then you get that stratification that is characteristic. I saw it in a series of metal samples. They look like they was leafing in the aluminum and metal. That should be critically studied as it is a very important thing that can help you to understand.

**George Hathaway:** You're suggesting specific gravity measurements?

**Marcel Vogel:** Absolutely.

**Jacques Gagnon (Montreal, Quebec):** Were there any of these effects when John was not there?

**George Hathaway:** None of the large effects have occurred when John was not there. We had some minor occurrences when I was personally adjusting the set-up, but I can't suggest that these were the same kinds of things that you saw because they could easily be blamed on merely electrostatics. And anyone can do lots of funny things with electrostatics. They were rather unusual, but I cannot claim to have seen anyone else, including myself, make the apparatus work. Basically that translates into: have the patience to sit with it and adjust it without John being there himself for hours and hours.

**Jacques Gagnon:** Roughly what is his background? Did he study how he thinks he is doing this?

**George Hathaway:** That's a good point. John has a high school education, and he does not have any formal electrical or university training. He has been experimenting with Tesla coils. In fact, the way he stumbled upon this was to try to duplicate Tesla's transmission of electrical power without wires. At an experiment, he inserted the Van de Graaf generator which he was repairing for a friend.

He cannot explain these things in terms that people who've had training in these fields would like to use. He talks about energy fields, he talks about energy moving around and being transported from one place to another. He talks about interaction

---

between energy and gravity. That is the extent to which he can explain what his understanding is. He has an incredible intuitive capacity to follow the flow of energy that he is trying to manipulate. Something far beyond me. I have no concept of the kind of understanding that he has. He's been at it since he was about 6 or 7 years old, continuously. He has a government pension for a medical problem so he has lots of time. Time is necessary to develop that kind of technology, if you are not concerned about particular results in getting somewhere. Unfortunately, most of the rest of us don't have that kind of time and we want to produce something that is tangible, something usable, something that we can develop into useful products. That is of very little interest to John per se. He's interested certainly in getting the technology moving, but not at our pace. And that has been one of the causes of having this thing sitting in storage and taking a long time to develop. So he has a good intuitive feel of what is going on. He cannot explain it in words that you and I could understand, and he's been at it for so long that it doesn't really matter. He has no need to converse with us in those kinds of terms, and I doubt that he could.

**Dr. Harold Aspden** (University of Southampton, England): I've been greatly impressed by this, of course. It's incredible. I would not have believed this from a distance, but it's great to see the demonstration and I have the confidence now that this is a real effect. My first reaction is that I would want to look at the breaking of the specimens with an eye to what is called the exploding phenomena. This is where you pass very rapidly, very big currents through the various wires and they break up into very tiny mm sections, as if they had been chopped up, with no evidence of melting. This is a phenomena being studied by Peter Graneau particularly and that should be considered in regard to rupturing process. I cannot escape from the fact that there must be some evidence, there must be some action of the ether in this activity.

I think the relevance of the tornado to this is of very great interest because there is evidence of patterns in fields, circular patterns in special groups and that has something to do with the magnetic fields that are created. That, to me, is evidence that you can get some kind of vortex or spin in the ether itself and I would look at this phenomenon perhaps arising from the induction of filamentary vortices in spins which tend to pull up these specimens. Having said that, and suspecting that there's another way, I would never go over a cup of coffee that's vibrating with a camera just above it, because my poor head would get in the way of these things and I'd be very scared to go anywhere near that type of activity. So I am a bit concerned that you can have all these things happening, and then moving with a camera to take those pictures! How close did you dare go to the real centre of activity?

---



**George Hathaway:** We were within 6 to 8 feet of it. John respects his apparatus when it's going, and he will not enter into it. He knows the limits of it and he tells us what the limits are, and we stay outside those limits. I suffered a severe migraine headache after my first two encounters with it, but I cannot ascribe them directly to the apparatus. I was so excited after seeing this thing work for the first time, and the second time, that my mind was going at 1200 miles per hour, and that is what I attribute my headaches to. John, on the other hand, has complained of microwave clicks deep inside his head. The microwave clicks are a phenomenon that has occurred in radar technicians, where for some time they hear clicking sounds deep inside their heads. John has complained about that but he has not complained about any major effects. We perhaps have just been lucky, or perhaps somehow, he has been protecting us. I don't like to bring up the PK (psychokinetic) end of all this but it certainly may be relevant.

Regarding Peter Graneau's work, I have discussed this with him and he is aware of what is going on. He is very interested in following it up, and as regards tornadoes, it's something as well that might be relevant. There is film evidence of the fact that tornadoes have very interesting electromagnetic phenomena going on inside them. Bodies levitating, going up and down very slowly in the eye of a tornado, and emitting showers of sparks.

**Marcel Vogel:** I want to add one more thing as a word of caution. Just taking water and spinning it around a crystal in the wrong direction I did but once in my life in 1984 and I was flung 10 ft. away from the experiment against the wall and the next day my face was burnt as if exposed to intense radiation. My eyes were closed. It was witnessed by five persons. That was only letting 100 cc of water spin around a crystal that was charged. So you must proceed cautiously these forces. I speak with experience.

**Bernard Grad** (Institut Armand Frappier, Montreal, Quebec): Just one comment. First of all, let me explain that I'm no physicist. I've had conventional university training in physics but I'm essentially a biologist and I'm especially interested in the energy fields of living things. The immediate thing that struck me about your talk is that the phenomena is very reminiscent of poltergeist activity. I don't want you to begin to think mystically as soon as I say this: I myself see a lot of poltergeist activity as a direct result of intense and disturbed energy fields in people living under specific circumstances. The fact that you noticed that this phenomena is seen only in the presence of this man and has been working in this from a very early age implies to me that his organism has a specific need in this regard.

I can tell you one little experiment. I've done work in relation to the energy. A healer was onstage, and to his side (the audience was facing him) was his wife sitting at a table, such as you are, with a microphone. The healer was there, and his wife was sitting in front of the microphone there. Over on the side of the stage was a generator. This was an unusual situation in the sense that the generator was there.

---

While he was healing, to the surprise and astonishment of everyone, a waveform appeared directly towards the motor to such an extent that it frightened and astonished everybody, but the thing was able to be dampened as soon as he stopped healing and as soon as she turned the microphone away. I just want to put some focus on this direction. I think these are very interesting phenomena, by no means mystical phenomena, I want to emphasize, but phenomena that can be investigated scientifically. Another total surprise: he's a person who never had a formal education, but he constantly speaks of energy field which is, by the way, the way many healers speak.

**George Hathaway:** We had considered that kind of approach (the PK psychokinetic approach) as a possible explanation as well. We tended to downplay that for a number of reasons including the fact that John was very excited about two particular demonstrations we were going to give for rather high-powered investors. On both occasions the apparatus failed. One could say that there was some kind of negative influence, and John's one unconscious side was fooling his other unconscious side into saying that he was not going to proceed with this. But he certainly was excited and he wanted to get going again.

**Anonymous:** My wife and I are in touch with John Hutchison regularly and we have a large archive of his information and he has stated that he does not wish this technology to be used for any destructive or military means and that he has kept certain information, so that it will not be able to be used by other people. And this may be one of the reasons why no one else has been able to replicate exactly what he has done, because he has not told anyone everything that he is doing, so that's one point I wanted to make and that may be why no one else has been able to replicate this.

**Bernard Grad:** Have you tried to selectively isolate components in the electrical experiment so as to pinpoint whatever may be the cause of this?

**George Hathaway:** We were going to embark on a program of doing just that in our last phase of work in 1982, but unfortunately things fell apart contractually with John and we were not able to continue that research. John had an interest in putting more things into the apparatus, not less. Unfortunately we were not able to continue.



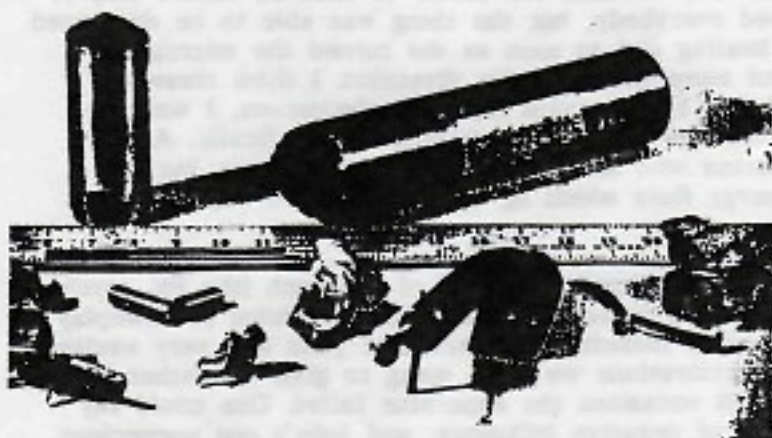

Figure 1. Examples of disruptive phenomena, including a broken bushing.



Figure 2. Two samples of disruptive phenomena: contorsion and segmentalisation.

---



Figure 3. Aluminium specimen from one of John Hutchison's experiments October 1984 (70x magnification)

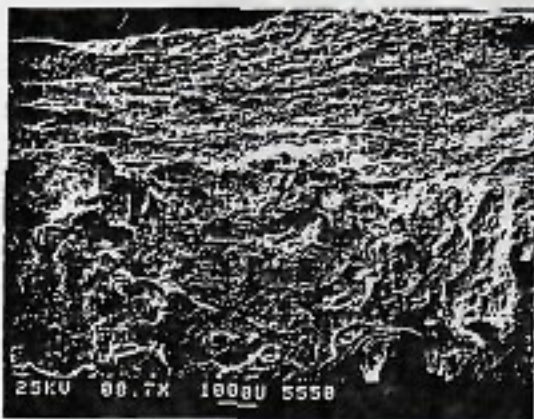

Figure 4. Fractured iron rod/bar which includes regions which were mapped by x-ray: see also figures 9 and 10

---

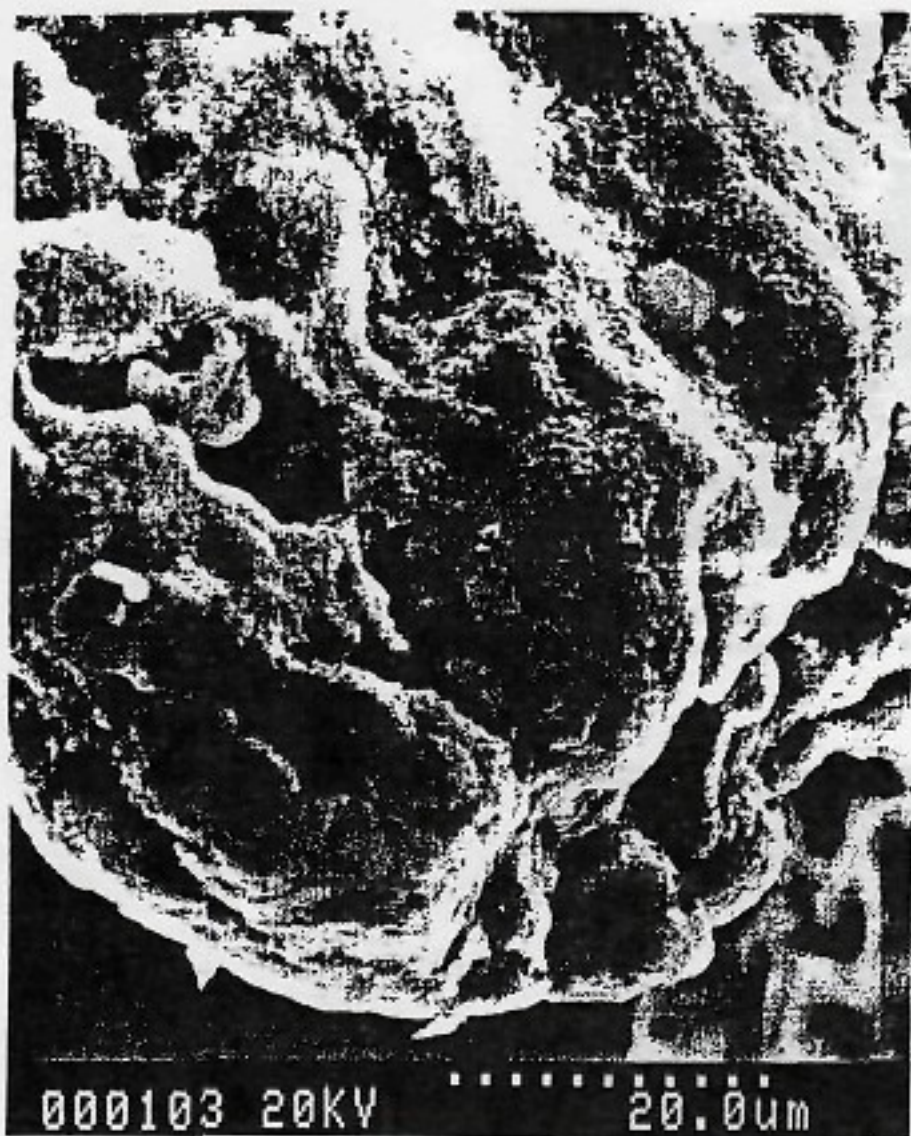

Figure 5. Scanning electron microscope photo taken at the University of Toronto of an aluminium sample subjected to the Hutchison effect

---



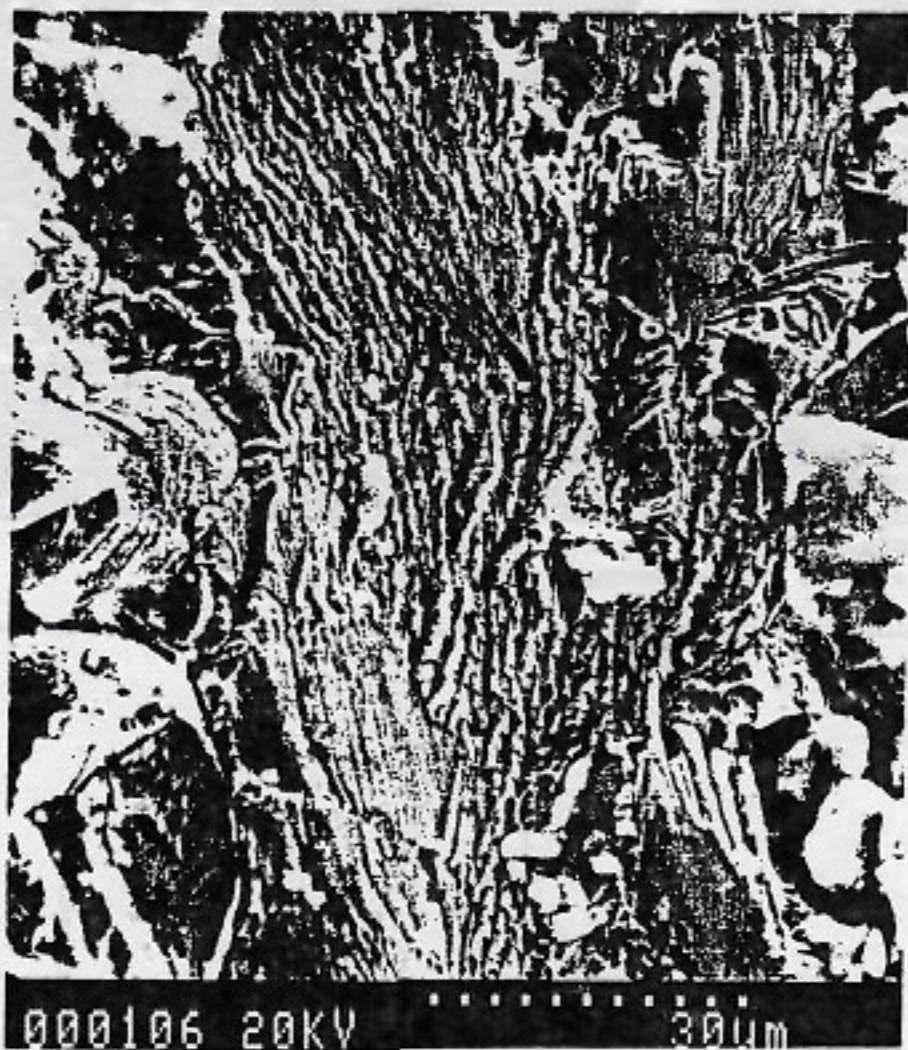

Figure 6. Scanning electron microscope photo taken of an iron sample subjected to the Hutchison effect



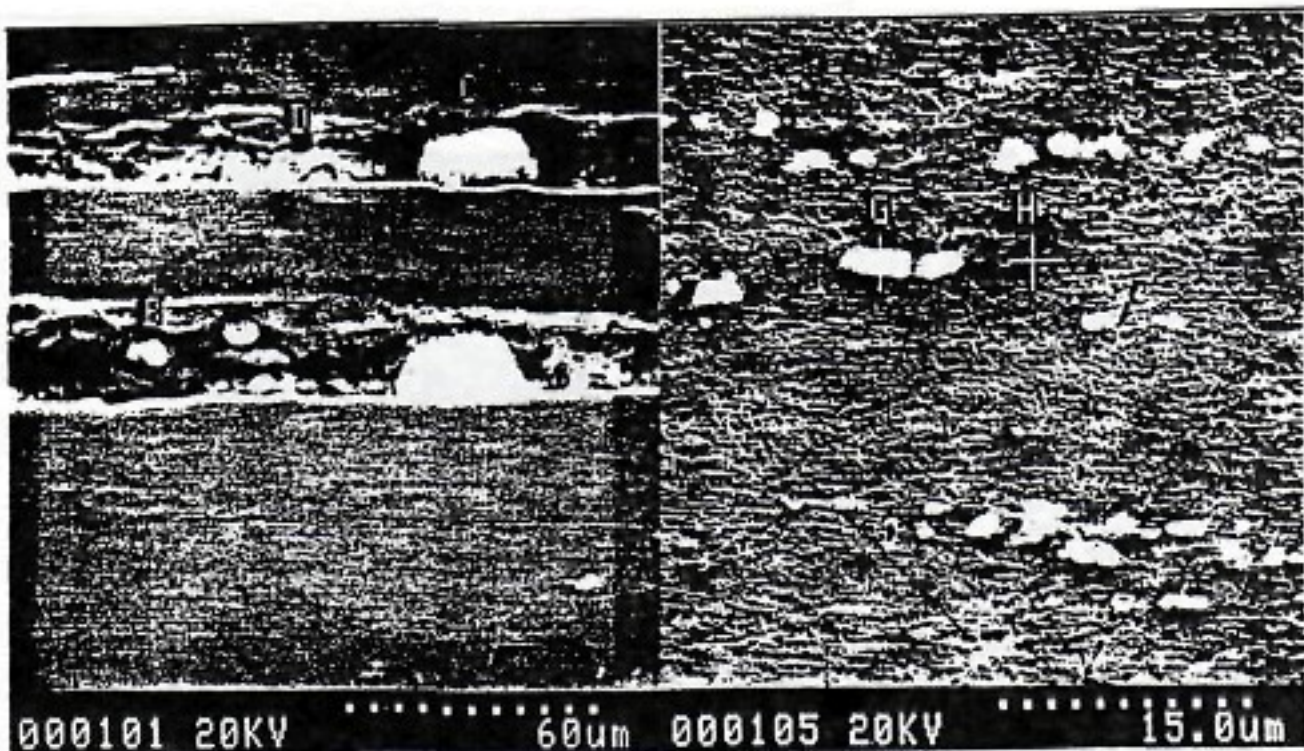

Figure 7, Figure 8. Higher magnification of polished aluminium sample with pure element globules emerging after Hutchison effect

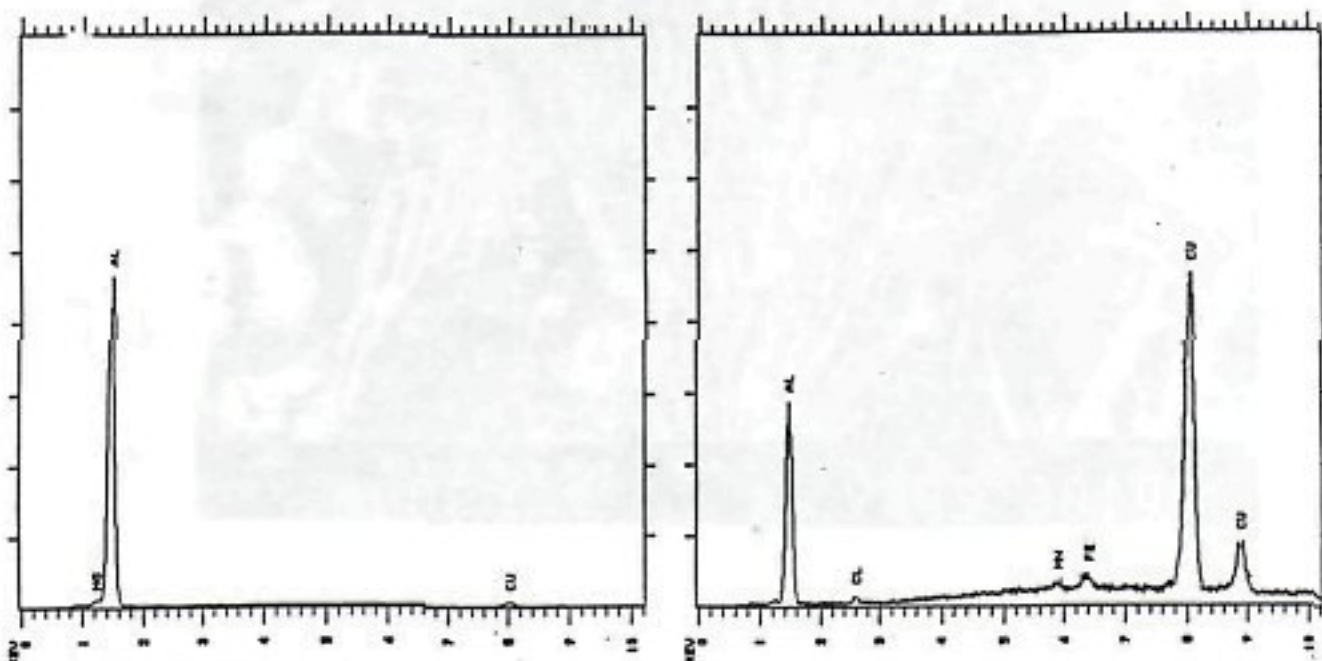

Figure 9, Figure 10. Spectral plots of typical aluminium sample compared with an area where fractures developed under Hutchison effect occurred

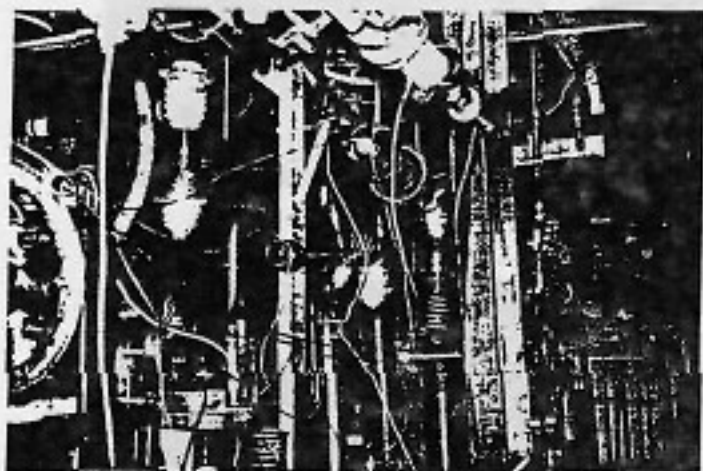
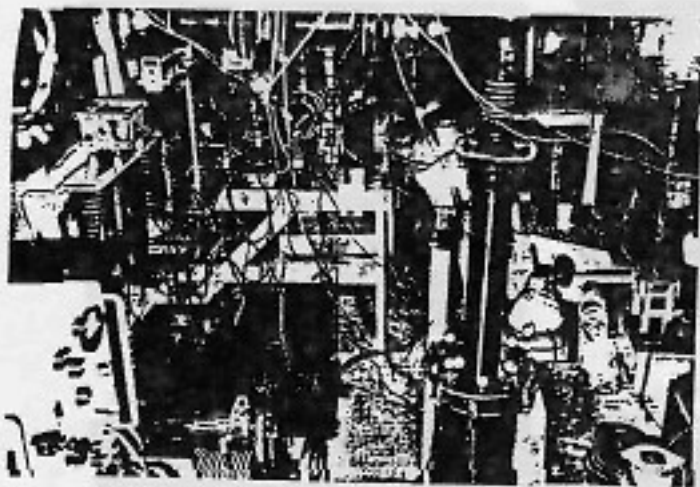

Figure 11, Figure 12. Above is a 1983 reenacted laboratory (Phase I) replicating John Hutchison's original set-up. Below is John Hutchison's 1987 (Phase II) laboratory before it was dismantled and in which were recorded by a Canadian television crew for national news numerous phenomena

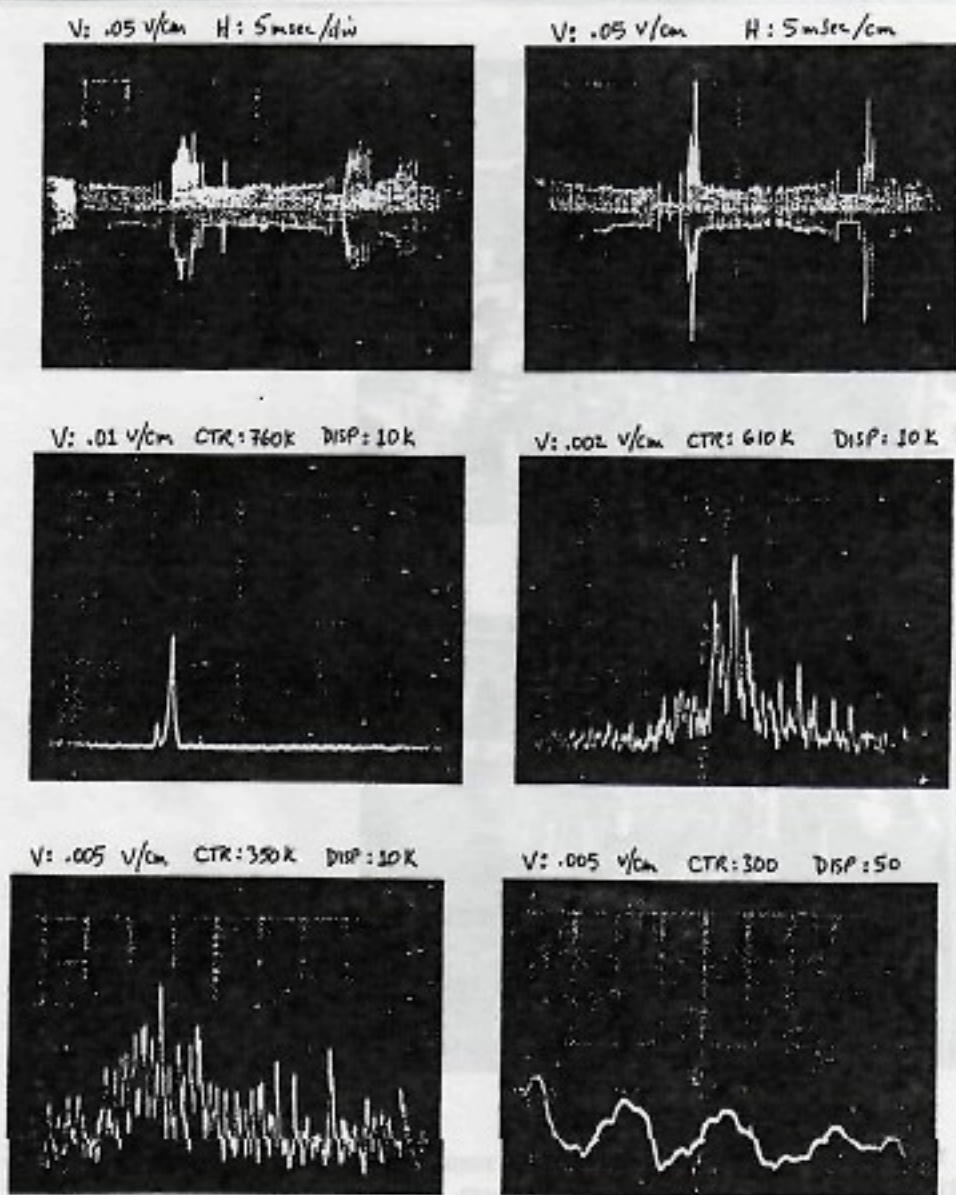

Figure 13. Field strength readings during experiments. Top 2 traces: 60 Hz bursts with classical Tesla coil decays. Middle left: small coil peaking at 760 KHz; middle right: 610 KHz sideband. Bottom left: large coil at 610 KHz. Bottom right: a 300 KHz emission source



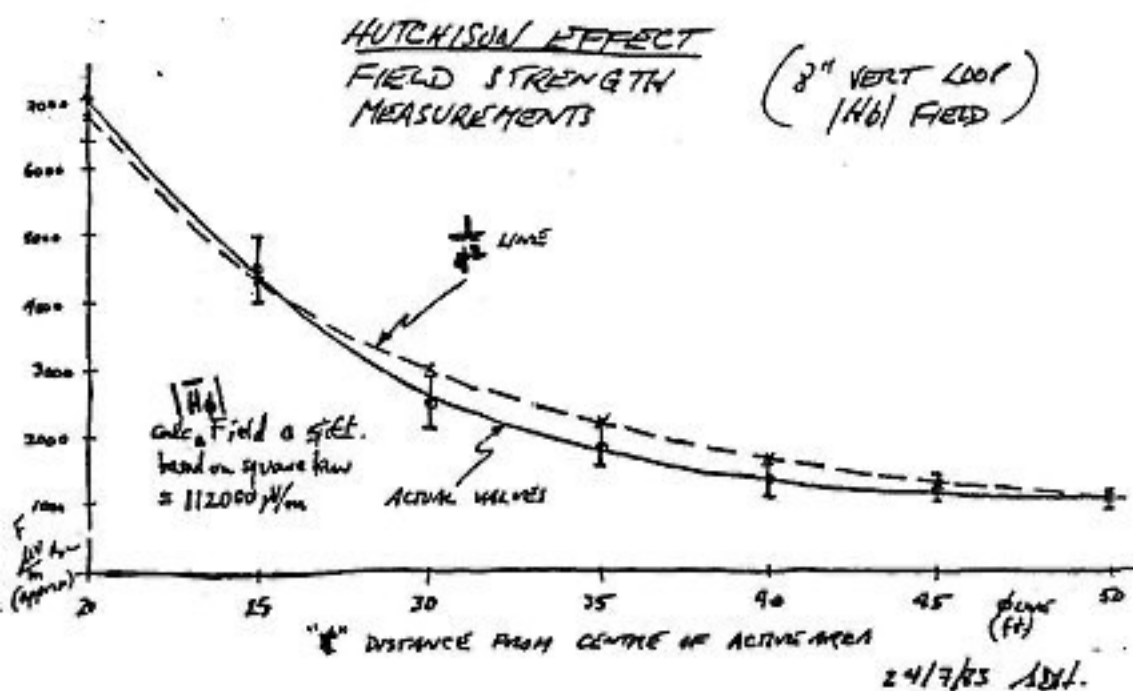

Figure 14. Field strength measurements during Hutchison effect experiments at about 350KHz, showing strength versus distance from source



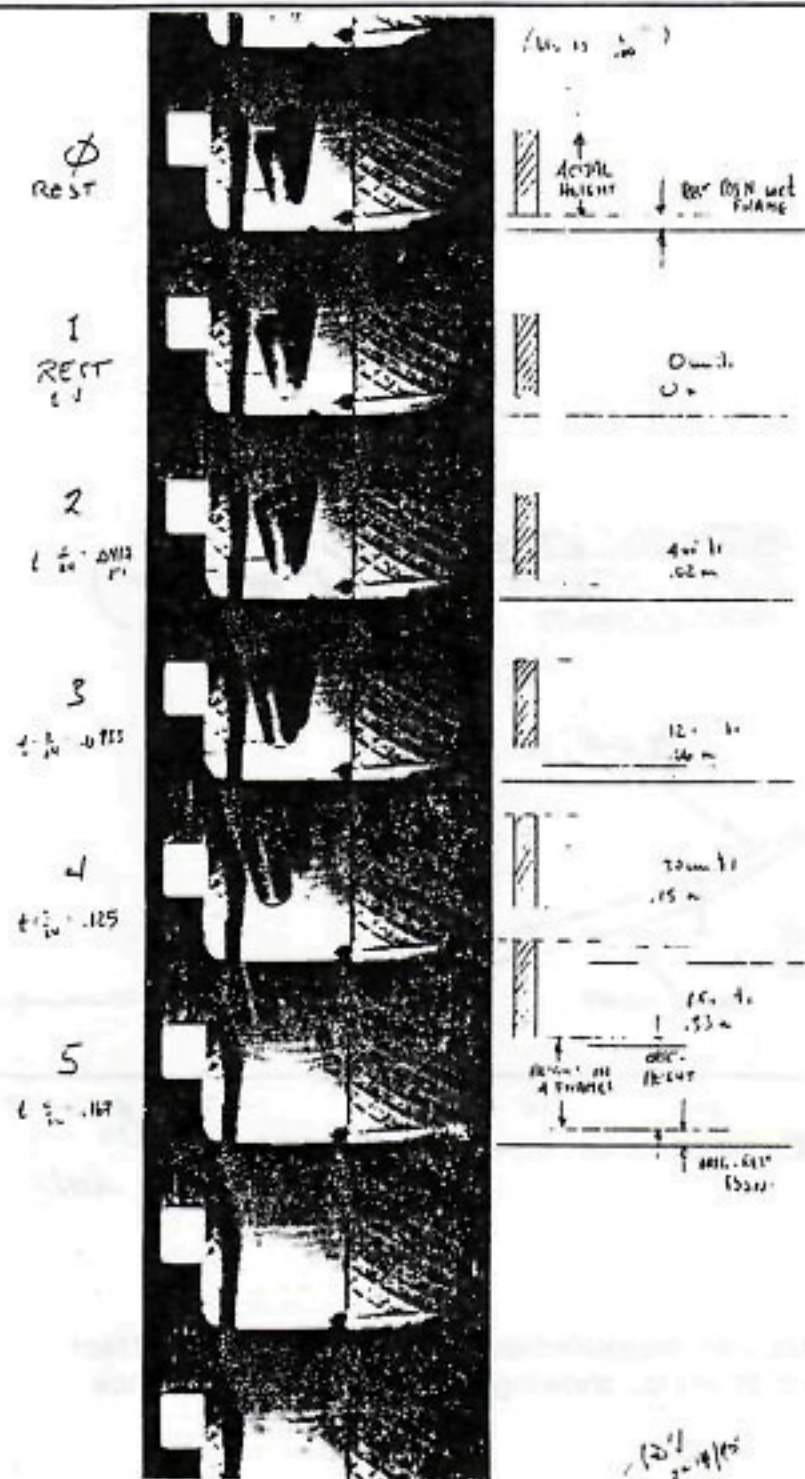

Figure 15. Strip of 8 mm film of a 19 pound bronze bushing in powered take-off, in slow motion

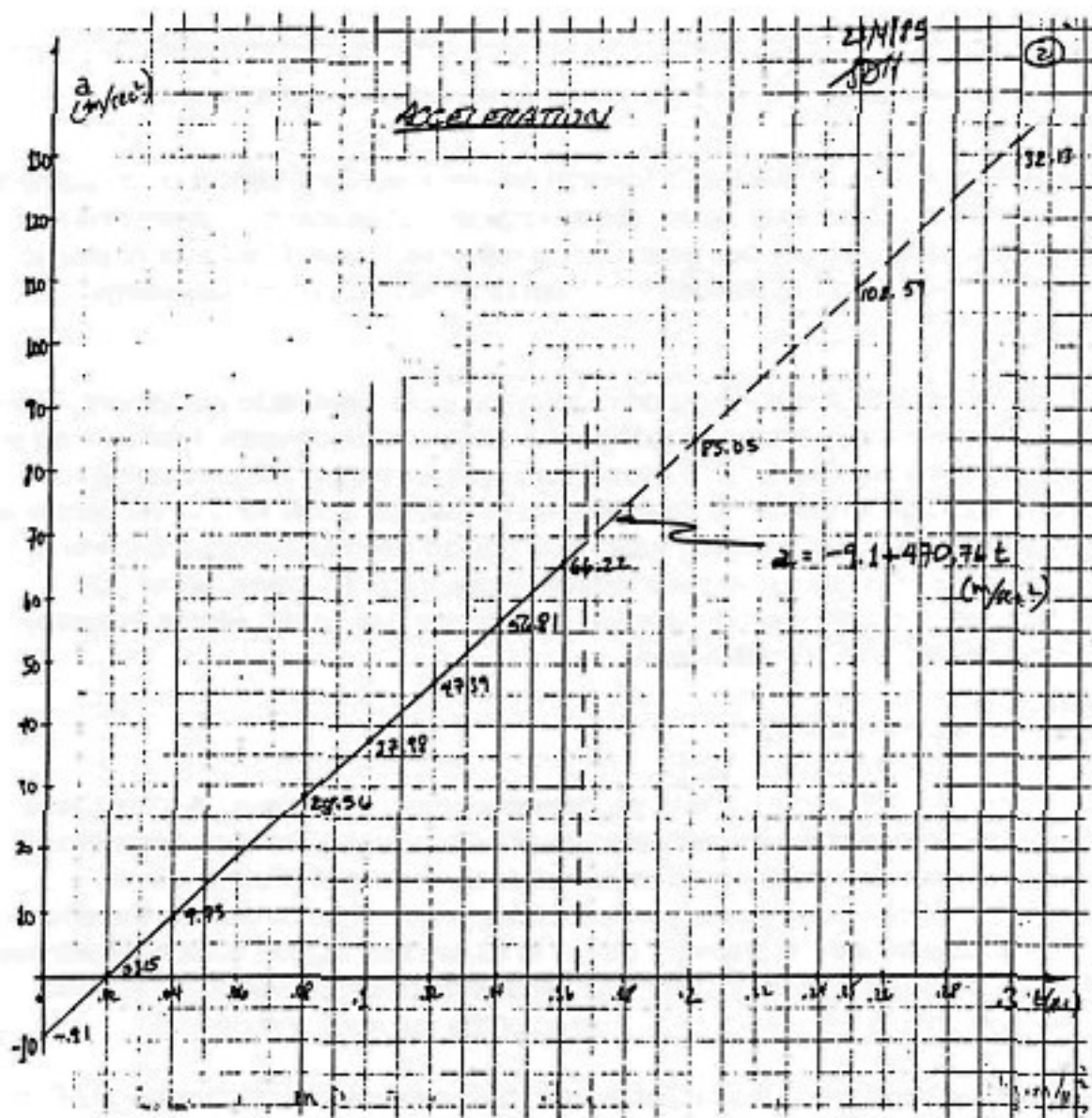

Figure 16. Plot of linearly-rising powered take-off of a 19 pound bushing calculated on an acceleration / time graph.

## The Hutchison effect - the inside view

John Hutchison

reprinted from the Planetary Association for Clean Energy Newsletter, Volume 6(2-3), May 1991. p. 18-19

Since a very early age, I have had a fascination with machines, almost an empathy to them – whether machine tools, guns, steam engines, chemical equipment and most of all, electromagnetic and physics gear. Being rather reclusive, I had a lot of time to work and play with a host of devices from ham radio equipment to free energy machines.

In 1979, in my lab that was a collection of machine tools, ham radio equipment, Tesla coils, static generators, transformers, RF generators and much more, I discovered an odd effect. Let me say that I would have Tesla coils turned on, RF generation equipment, static generators and geometric metal masses under load in the centre an uranium alpha beta flux in a copper tube. The effect I saw led me into a decade of demonstration to Defense, aerospace, private groups and TV crews, about 700 demonstrations. I should mention who led me into this new world: **Alexis Pezarro**, **George Hathaway** and **Tom Bearden**.

### Decade of demonstrations

Between 1979 to 1986 about 60 % of my demonstrations took place. A lot of these failed while a considerable number were classified by various Defense departments and the Los Alamos laboratory (and written statements to that effect are in my possession). In those early years, we would have credibility problems as the effects go against the classical laws of physics. But all in all, we had a good number of witnesses and videos. Between 1986 and 1990, my demonstrations improved to 80 % effect generation an up to 5 effects per hour instead of the previous one per day.

I embarked on a program of larger Tesla coils, high capacitance, high voltage AC on interferometers, rack cabinets full of RF signal generation equipment and low power radar systems, broad-band output generators and phasing equipment coupled to the signal generators, the uranium source now was housed in a stainless steel ball. This ball had a window so that the alpha beta flux could be rotated. Next to the steel ball was a pulsed magnet pin network. The output horn was phased to the window. The steel ball was subjected to a DC tension of 100,000 volts. To go into further detail is beyond the scope of this article. However, I felt that the more sophisticated equipment would replace lots of the old setups I had previously and it turned out so.

## **Data gathering period**

I had now, in the second phase (1986 - 1990), more monitoring equipment: such devices as a panoramic spectrum analyzer (0.1Hz to 44 GigaHertz) with chart recorder, magnetometer, and a variety of detectors.

Some of the most interesting at a distance -- up to 30 meters (100 feet) away include the development of magnetic monopoles, the production of transparence in metals, the falling apart of bars of steel, the mixing of metal with wood (this sample is still under investigation in Germany by **Siemens**), levitation of many kinds of materials in various weights, sizes and shapes.

## **Surprise, surprise**

Two demonstrations were a surprise to me. One day, when I was alone on a test run, I walked over to the back window in my laboratory. I had let all the machines work on a sample as I was getting ready for a demonstration. From the window, I saw the telephone pole in the lane shaking violently with at least 3-foot movements, back and forth. So violent was this movement that the wires were flapping around like a skip rope. At first I thought a car was tied up by a guide wire. I opened the door and looked outside and saw no car. But I did see a crowd of persons looking at the pole from a club next door. I then went inside and slammed the main breaker closed. The action stopped.

On another occasion, in 1985 or 1986, I ran a test and shut down the lab as I was to visit a friend. I put on my coat, got my bike and locked up the lab. I then noticed one of the most breath taking effects. Above me was a huge dark cloud formation -- in a spiral form, not too distinct yet. I thought of how Tom Bearden talked of weather control and standing columnar waves. I wondered if I could outrun the storm as I knew rain would come shortly. I got on my bike and went a half kilometer and then saw the formation dump the rain. I watched for a while at the clouds were getting into a normal pattern. During my ten kilometer trip, I would stop and look back at the cloud. Eventually, the sun was shining through thin spots. At the time, I thought that this was coincidence. This was a nice memory.

## **Demanding investors**

1988 was very demanding, as I got involved with investor types from **Boeing** and from throughout Canada. The usual effects took place. One of them was nails passed through wood, as if the wood were transparent and the nails had levitated and got caught in the wood. In another test, a 1000 pound transformer levitated -- and this is captured in a stolen video. One effect I played with is the control of background radiation levels within a spherical radius of 75 feet. This effect was recorded by an European team using my spectrum analyzer and they recorded this effect on video.



I was locked out of my lab by the Boeing investors who wanted me to follow their psychotronic approach yet I got in the lab with the other group who documented everything. A British Columbia Court order came later on allowing me access to the lab to do research, but permitted the Boeing group the same.

### **German investigate research**

By now I was going to Germany to see my friends and to see all the tests being done on fifty metal samples by six major labs over there. These labs were with universities and institutes. While I was gone, my lawyers failed as various Canadian government agencies took all the high voltage equipment and machine tools. But in their awkwardness, they did not take the most valuable equipment. Tom Bearden has indicated that the Canadian government did not want me to have my lab so they used Environment Canada to clean up. Yet the six tons of important equipment is now safe.

In Germany, I found that the samples had been transmuted; that they kept on changing their characteristics. Also, some of the metal, as view microscopically, is transparent. Slowly, a large network of high ranking scientists gave support to the effects. I have not yet received one negative response. They wanted me to work alongside them while my lab was in Vancouver.

### **Return to Canada**

I returned 18 months later, on September 1990 to get the other half of my lab out of storage -- that half that the Government had not seized. I only found a mystery getting bigger and bigger about the part of the lab that I lost. Members of Parliament would not talk to me nor help. And there were all the stories going around about **CIA** intervention. At least I have some documents about this.

### **Rationalizing the "Hutchison Effect"**

Now, what is the "Hutchison Effect? My peak power was 110 volts at 400 volts. This of course was transformed to signal generators, radar systems, broadband systems and high voltage systems and magnetic pulsed coils (4Hz) with an overlap of saturation in the iron core so that one would have a waveform showing this.

If one was to study **Rene Louis Vallee's** and Tom Bearden's work on time reverse waves and scalars, one could see how both phenomena lend to this effect in some way.

Vallee does predict a depletion of energy in the structure of space in the vicinity of an earth sized concentration of mass of 57,000 MegaJoules less per cubic meter than that of a cubic meter of interstellar space. If this is so and the potential does exist, then the energy available to produce the observed effects would be of the proper magnitude. Assuming less than 100 % conversion efficiency of my equipment and given the

dimensions of the samples, it would seem that the more massive a sample, the greater the potential energy flow.

The apparati seem to conform to Bearden's time reverse scalar wave concepts. Looking at Dr. **Elizabeth Rauscher's** third equation, and comparing my own ideas about sub-atomic particles, I note a set pattern that I wish to follow up on which could lead to a comprehensive rationale. The above-mentioned contributors have led me to investigate more carefully radar systems, nuclear, signal generation, other electromagnetics and the Tesla coils for a future demonstration by which effects might be engendered on a continuous basis. Some minor tests already indicate that such continuity is a fact.

### **Possible applications**

Some will say, what can the "Hutchison Effect" be good for? Maybe: gravity space propulsion systems, medicine, new materials, open doors into "free energy" systems, sub-atomic physics, time dilation, pollution control and nuclear waste management and disposal systems and, interdimensional physics.

To render the above feasible, I hope to develop and set up my lab in Europe later on. In successful demonstrations, I hope to call in the people mentioned in order to bring forth the technology at a faster pace where it can be used for pollution control and in medicine. The sooner the better, I feel.

## Independent Assessments of the *Hutchison Effect*

A number of explanations have been written by parties who analyzed the facts associated with the research of John Hutchison. These appear to fall into several categories: 1) psychokinesis, 2) electromagnetics, and 3) combination of psychokinesis and electromagnetics. Below are the complete, un-edited reports.

### 1) The psychokinesis hypothesis

#### *Private Report by Billie Ross*

##### **Demonstration of the Hutchison Effect**

October 14, 1985, 8 to 11 p.m.

Pieces of metal about ten in all ranging from brass piping, aluminum piping, aluminum foil, copper and a large piece of foam rubber also a rectangular piece of aluminum and a short piece of Vanadium all were placed on a piece of *Formica* counter top which served as a table. The *Formica* was slightly curved (concave) due to warpage, I felt this would allow the pieces to slide outwards and simply fall off. The moving incident happened at about five to ten minute intervals.

Electrical machinery were revved up. On my left facing, a small piece of foil teetering on the table's edge has moved and fallen off. This followed by a second piece on my right. Two bars, the long thin one and a short one, slowly separated approximately 1/4". On my right further down the table the third bar, that was in alignment, became a bit slanted; then straightened to its original position. The thick aluminum bar appears to be shifting it's shape and what appears to be a dark gray oblong spot is forming on the inner side (left) it has moved a little more from the longer pipe. The largest piece of foil has been rearranged. Two or three fairly loud thumps (heavy) were heard upstairs apparently these premises were vacant at this time. The fourth metal pipe has moved up a bit towards the back end of the table (Note: it is possible that I never noticed the space on the table between the bottom of the pipe and the piece of foam before). On my left, the large piece of foil is rearranging itself and is moving towards me. On my left a small piece of foil has also fallen off the table, just now it appears that a sort of metamorphosis of the short thick piece of aluminum is taking place, I will check it out after the demonstration. As predicted, the large piece of foil has also fallen off of the table.

The first and heaviest long thin piece of brass pipe has literally "jumped" from the table taking the short aluminum rectangular piece along with it. The short piece of Vanadium has seemed to be misplaced, probably it has fallen to the floor unnoticed or has moved under piece of the remaining foil. Another piece of foil on my right is a moving forward and close to the edge of the table.

*A candle is being placed on the table, thus ruling out my suspicions that a draft might have been responsible along with the concave Formica for the foil in particular to have moved as it did, as the candle flame is completely still.*

The flame did however flicker very abruptly as though a sudden wind entered the lab when the "D.C." exploded. The electrical devices have now been down. The demonstration was about 1 1/2 to 2 hours long.

### Observation

The aluminum bar has been severed. However, I must remain at least 5% dubious at this time, that the piece had not been scored before it was placed on the table as the separation appears to have been marked perfectly straight across one side, but I must admit that it probably was not since I have too much else occur which obviously was genuine and not a trick.

It would be interesting to have a demonstration to rule out any telekinetic influence of the effect that might emanate from John. As the foregoing paragraphs will show telekinetic effects of such a nature has shown up often in the past.

I refer here to the excellent book by **Edgar D. Mitchell**, *Psychic exploration*, dealing with all aspects of phenomena, written by many world-renowned researchers and scientists.

Notably the following: chapter 7, pages 179-194 in which **Helmut Schmidt** in his writings on *Psychokinesis* has shown that "during the last four decades careful laboratory work has shown that man to a certain degree can influence the outside world by pure thought". This process is called *psychokinesis* or *PK*.

It appears in the laboratory as a mental influence on "random" events like the outcome of die throws or the *operation of electronic devices*. I also note from the same book, Chapter 16, by **D. Scott Rogo**, particularly his notes concerning *poltergeist activity / poltergeist agents*, especially poltergeist agents. The subject usually has a low verbal ability at expression.

This coupled with built up hostility and frustration, and a crippling inability to express this hostility. Normally when such a situation arises, a person will allow psychological mechanisms to help him release his frustration as in *displaced aggression* in which a child, angry at his sister, will kick a door or a pet. Another such mechanism is "acting



out" as when a child perturbed by his parents, will tear pictures of adults out of a magazine. The poltergeist does just this. *But instead of the individual carrying out his hostilities physically, his PK does it for him.*

Poltergeist agents also show denial so it seems, and suppression. These are attempts by the child or adult to deny feelings of hostility or suppress them into the hidden regions of the unconscious because of this, it is not odd that poltergeist outbreak agents are often unaware that they are actually causing the outbreak. Further, it has been found the movements of objects do seem to follow certain principles. These principles are enormously complicated, but they point to the effect that objects around the agent will tend to be moved more often than objects at a farther distance. The trajectories of these objects seem to indicate that some moving force, *vortexian* is responsible for the actions.

The above findings may sound somewhat "too dramatic" in relating them to John. However, one only has to look at his upbringing, his past personal experiences and his present lifestyle to see the bizarre similarities. John does have a quiet gentle and somewhat naive personality *albeit* much of his seemingly placidness, I believe, harbors much hostilities and frustration, from early childhood to the present time he has lived a complex life, John has been done wrong in his early years by incorrect treatment by an ignorant medical profession: he was treated for a serious mind imbalance when it was a simple case of agoraphobia. Who would not harbor malice. He was the victim of an alcoholic parent. In later years he had to contend with dishonest bureaucrats but it probably was the lifelong exposure to the alcoholic environment.

John is somehow shy, but is what "looks" if you will in his subconscious that causes effects similar to the disturbed child that D. Scott Rogo cites above.

John's extreme quiet and extreme mild-mannerisms do act as a somewhat crippling inability to express pent-up hostilities, he does "get even" with his antagonizers in a "passive" aggressive way. Does a poltergeist manifestation occur then? Why is it that when he is feeling happy and positive, a demonstration goes well, and just the opposite occurs when he is downcast and feeling negative? Does he have some or all control of the effect without being aware? Is he being led to believe that the effect is indeed more of a *detached* scientific occurrence or is it possibly a PK effect?

Future demonstrations may explain these questions, if the effect is caused by John himself it would be of a theoretical PK event as D. Scott Rogo has already brought forth.

It would appear that **Jack Houck** is probably more on the right track than anyone else.

## Letter from Jack Houck

February 28, 1991.

Your recent letter to me suggests you are experiencing more paranormal phenomena than the "normal" people do. Of course you know this is of great interest to me. I meet a lot of people in paranormal research activities who describe similar experiences. In general, you are having your mind go out and access (connect) with remote people and things. I am enclosing my original model paper which provides a way of thinking about how the mind can go out and access remote information. I know I sent this paper to you years ago, but it may have been misplaced with all the international traveling you have been doing.

The key point is that you can learn to control when and where you want your mind to go. Similarly, you can be open to another (e.g., Larry or Yin) accessing your thoughts or you can block that by simply mentally putting those thoughts you do not want others to access in a safe, and *close the door*.

I think that it is good to have the capability to sense things, like electromagnetic fields, when you want to. This can be controlled by setting a goal, making a mental connection to that goal, commanding it to happen, and then letting go (allowing it to happen). These are the same basic instructions I use to teach people to bend metal with their minds. The instructions work reliably when you understand how this can work, and practice. The same applies to creating additional energy in a generator. In many of your experiments there is a lot of "normal" energy around (e.g., your microwave radar). I think you want something to happen — the goal!! Your mind goes out and coheres the local available energy which then creates a force which attempts to achieve the goal. The letting-go step seems to be the most important from all my research and you seem to do that very well. Improving your reliability requires a lot of practice, a good model, and *not thinking* about it too much. Further, by making your goals very precise and specific, this process can be perfected. Creating a peak emotional event at the time you want the phenomena event to happen also seems to be an important ingredient.

I have always said that it would be nice to have a temperature sensing device on a woman who sees her child under a car. As she lifts the car off the child, I think there will be a 20 degrees drop in the local air temperature. Clearly, she has a goal — get the car off the child. This is a peak emotional event. She does not think about not being able to lift a car. The thermal energy in the air is extracted and a force is cohered which helps her lift the car.

John, I hope this information is useful and good luck in your continued research. Say "Hello" to Yin for me.

## Vancouver experimental observation by Jack Houck

August 1985

### Section 1: Summary and Conclusions

During the year 1971, John Hutchison set out to build some Tesla coils. He also is a collector of old high voltage and static electricity generating equipment, as well as a gun collector. One evening while tinkering with this equipment, creating large sparks and high voltage effects, he was struck on the shoulder by a piece of metal. He threw it back toward where it came from and it struck him again. He had accidentally created what we will call the *Hutchison Effect*. During the ensuing years, he found that by

adjusting the settings on the equipment, things would levitate, move horizontally, bend, break and explode.

Hutchison met **Alexis Pezarro** and **George Hathaway** who had formed *Pharos Technologies Ltd.* in search for new innovative technologies. Pezarro and Hathaway worked with Hutchison, conducting many experiments in attempting to replicate and understand the phenomena. They also were looking for funds to perform the research necessary to apply this knowledge. The equipment belongs to Hutchison and is in his residence. The area in which the majority of the effects occur is determined empirically. Often major events occur outside the intended "target area" where test objects were placed. In the early days of their experimentation, many hovering and apparently antigravity-type events occurred.

Hutchison and the equipment have moved twice in last few years, requiring many months to again obtain effects. During this time, more power and equipment have been added to the "system". Lately, most of the observed effects have been metal exploding or bending, and objects moving horizontally or expanding and contracting. A group of scientists from Los Alamos had witnesses and experiment last year with no results.

On August 13 and 14, 1985, this author had the opportunity to witness two evenings of experiments. I had taken a number of samples to put in the vicinity of the equipment at the intended target area. Most of the samples and controls left in Southern California. I took 35 mm pictures, and rented a 1/2-inch home video recording system for documentation and assistance in observation. There were some very interesting events captured on the video tape, and some of those were observed when they happened. Aluminum foil pieces and some other samples (including plastic) were observed to slide or fall over, as if hit by an impulse at apparently random intervals throughout both evenings. At one point, one of the aluminum foil pieces appeared to move up and down, with a 1-3 second period.

I was satisfied that no fraudulence was occurring, and was impressed by the fact that most of the events were covered by the video camera. However, some of the biggest events occurred outside the intended target area. The first evening, a gun barrel and a very heavy (60 lbs) brass cylinder were hurled from a shelf in the back corner of the room onto the floor. Simultaneously, on the opposite side of the room toward the back, three other objects were hurled to the ground. One was a heavy aluminum bar (3/4" by 2-1/2" by 12"). It was bent 30 degrees. Hutchison said that it was straight at the beginning of the evening. Another object was a 15-lb brass bushing. These objects can be seen falling in the video record, but their initial location is not recorded. I am quite sure that no one was hiding in that part of the room throwing these objects. I was with both Hutchison and Pezarro during the entire experiment.

None of samples I had were affected. There was a 4 by 4 array of small magnets set up in the target area. The first evening these magnets were spread all over because a big brass cylinder fell on the board supporting them. It actually fell onto the calculator, but the calculator continued to function. However, during the second day, no objects fell



into the target area containing the 4 by 4 array, but the magnets did move around, apparently due to the same horizontal force that pushed the aluminum foil pieces off the board. More detail on the objects that moved is contained in Section 2 of this report.

Pezarro and Hutchison reported many stories about what they observed in previous experiments.

I was struck by the many similarities there were to the type of phenomena I observe at PK parties and the type of phenomena associated with other types of macro PK (psychokinesis) events. Could Hutchison be electrically stimulating the same type of energy or "fields" that are responsible for PK events? There are also some dissimilarities. This comparison will be made in a Section 3. Might they have discovered a PK amplifier? It is possible that I could be biased because of my research into the PK phenomena. Pezarro believes that they are creating some type of "field" that stimulates some energy to be dumped into the objects, or used by an object's surface to generate the observed effects. No one has a theoretical explanation for what is occurring. However, if a better understanding can be developed, then it may be possible to devise experiments whose results can be predicted. Several theoretical approaches may be relevant (e.g., [Tom E.] **Bearden**, **Williams**, [Prof. Elizabeth] **Rauscher**, [Prof. William] **Tiller**, [Prof. Jack] **Dea**, *et al*).

In conclusion, I believe that Hutchison is creating a real phenomena with his equipment that is somehow being stimulated by some combination of the electrical fields being emitted. Currently, the effects are so random in both time and space that it is very difficult to conduct meaningful experiments. However, if someone can figure out a way to focus the effects consistently in a target area, then much more anomalistic data would be produced. Ideas were discussed on how to accomplish this focusing. There are many other parameters involved in each of the elements of the equipment that need to be better understood in order to obtain consistent effects. It is likely that effects are being created that cannot be explained by conventional physics and, therefore, some of new models being created to extend physics, in attempts to explain anomalous phenomena, could be examined in conjunction with the *Hutchison Effect*.

## Section 2: Experimental Data

On August 13, 1985, I flew to Vancouver, B.C., Canada, from Los Angeles to observe the *Hutchison Effect*. Pezarro met me at the airport and helped me get settled into the hotel. Pezarro talked about their experiments. I rented a video camera and recording equipment. We took the equipment to Hutchison's residence and set up the equipment and samples in the target area. They cannot run the equipment during the day because it disturbs all the electrical equipment of the neighborhood. The video camera was placed on a ladder, about 15 feet from the target area and cabled to the recording equipment located in another room. The room which contains the equipment has two narrow walkways, and old electronic equipment is stacked to the ceiling on the outside of both walkways.



The center of the room contains a massive amount of equipment, including a lot of power conditioning equipment, two very large *Tesla coils*, several *Van de Graaff generators* (only working as part of the "system"), a *Jacob's ladder*, and a big spark gap generator. I did not get into the details of the equipment because that is not my field, and Pezarro said there were "secret" elements. The first evening, August 13, we started the experiment at 8:45 p.m.

Table 1 lists the major events that I recorded.

Time	Event
8:45 p.m.	Start..
9:10 p.m.	Big brass bushing - 17 lbs - fell over onto the area of my samples; knocked the magnets around. Aluminum foil behind bushing was moving up and down slightly.
9:46 p.m.	Large pieces of aluminum foil fell off left side.
9:50 p.m.	Large pieces of aluminum foil fell off left side.
10:00 p.m.	Something fell off the shelf in the back part of the room (left side) as well as directly behind the target area.
10:19 p.m.	Lights and fuses blew out.

Table 1. Table of events on August 13, 1985.

Figure 1 is a sketch of the room and shows where things were generally located. It is not to scale. The direction of travel of the movement of the objects is noted in Figure 1.

Photos 1 and 2 were taken of the target area before the experiment began on August 13, 1985. The samples I had taken were on the "table" toward the front of the room (closest to the camera). There were two large metal rings hanging from the ceiling over the target area that slowly moved periodically throughout the evening.

Photos 3 and 4 were taken after the fuses blew out with only a candle to check things out. It can be seen that things in the target area had moved around. The cylinder on the second table fell over onto the first table. The major action during the first evening was toward the front of the second table. It can be seen in the photos that some of the aluminum foil moved around, and this is verified on the video tape.

Photo 5 was taken from the target area toward the front of the room capturing one of the *Tesla coils* and the *Van de Graaff generator*. This picture provides a sense of the amount of equipment and cramped conditions. Throughout the evening, Hutchison was constantly changing the settings on all of the room. Photo 6 was taken of the things that had fallen on the floor near the end of the first experiment. This photo was taken down the left walkway.



Photo 1

Target area: Hutchison samples

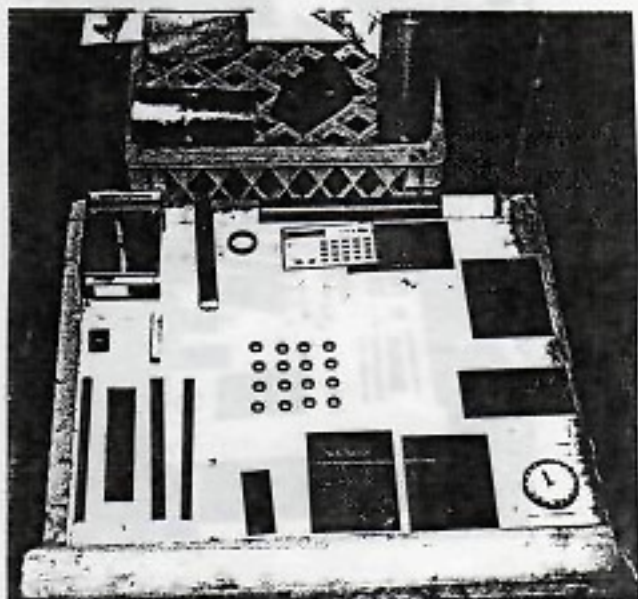

Photo 2

Target area: Jack Houck samples

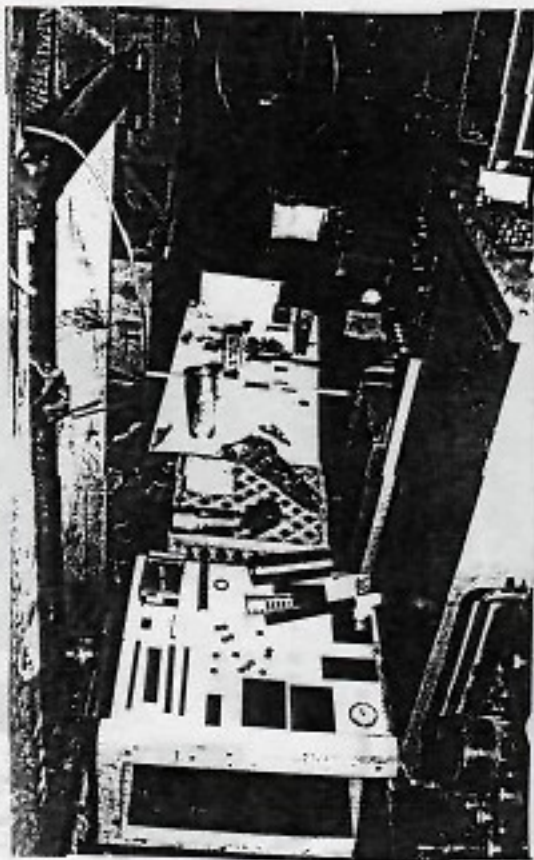

Photo 3

According to video, the table floated up along the walkway



Photo 4

"Things in the target area have moved around."

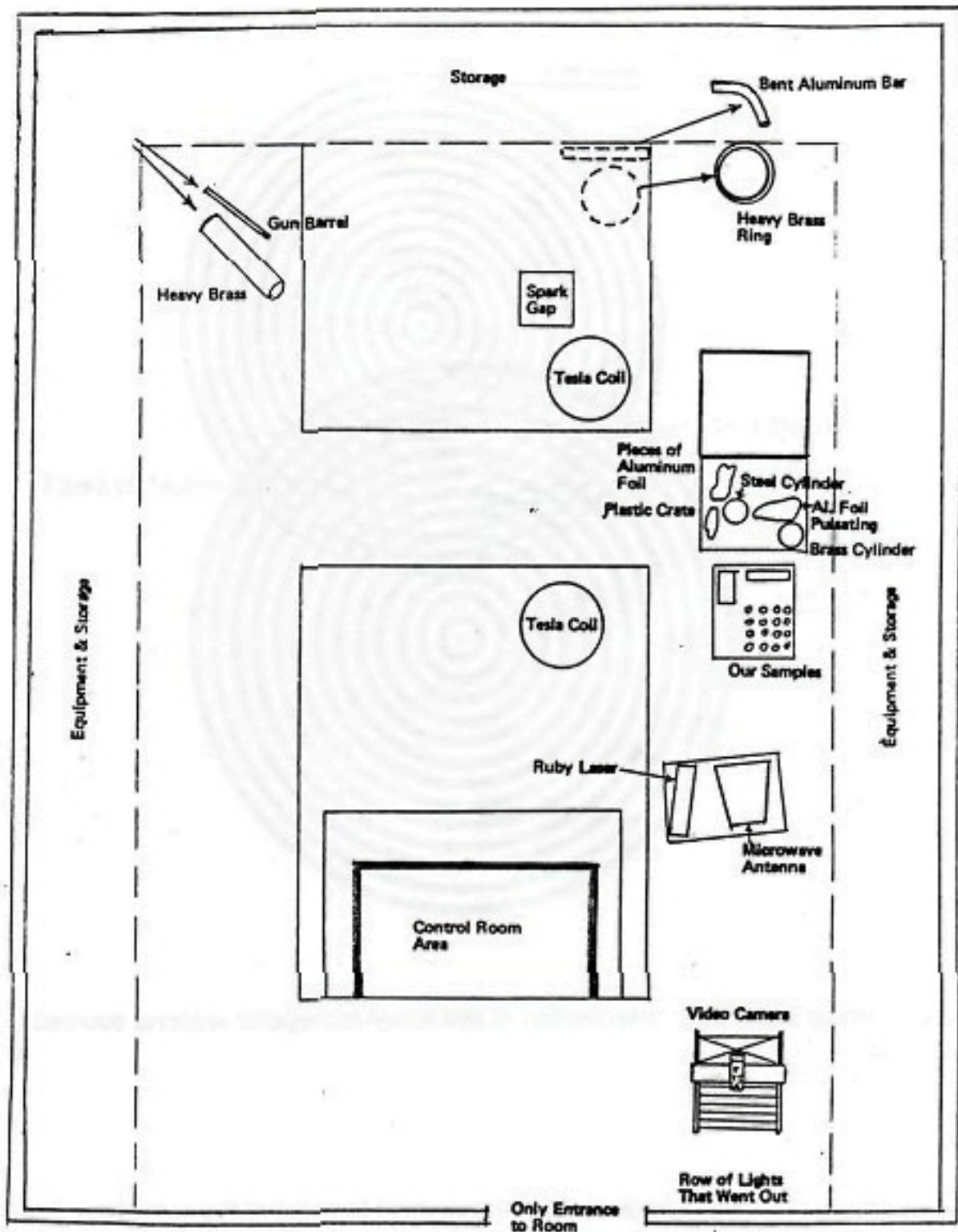

Figure 1. Sketch of the experimental set-up in room, describing location of samples, selected instruments, control area and the direction of displacement of artifacts affected by the Hutchison effect. August 13 1985. Not drawn to scale.



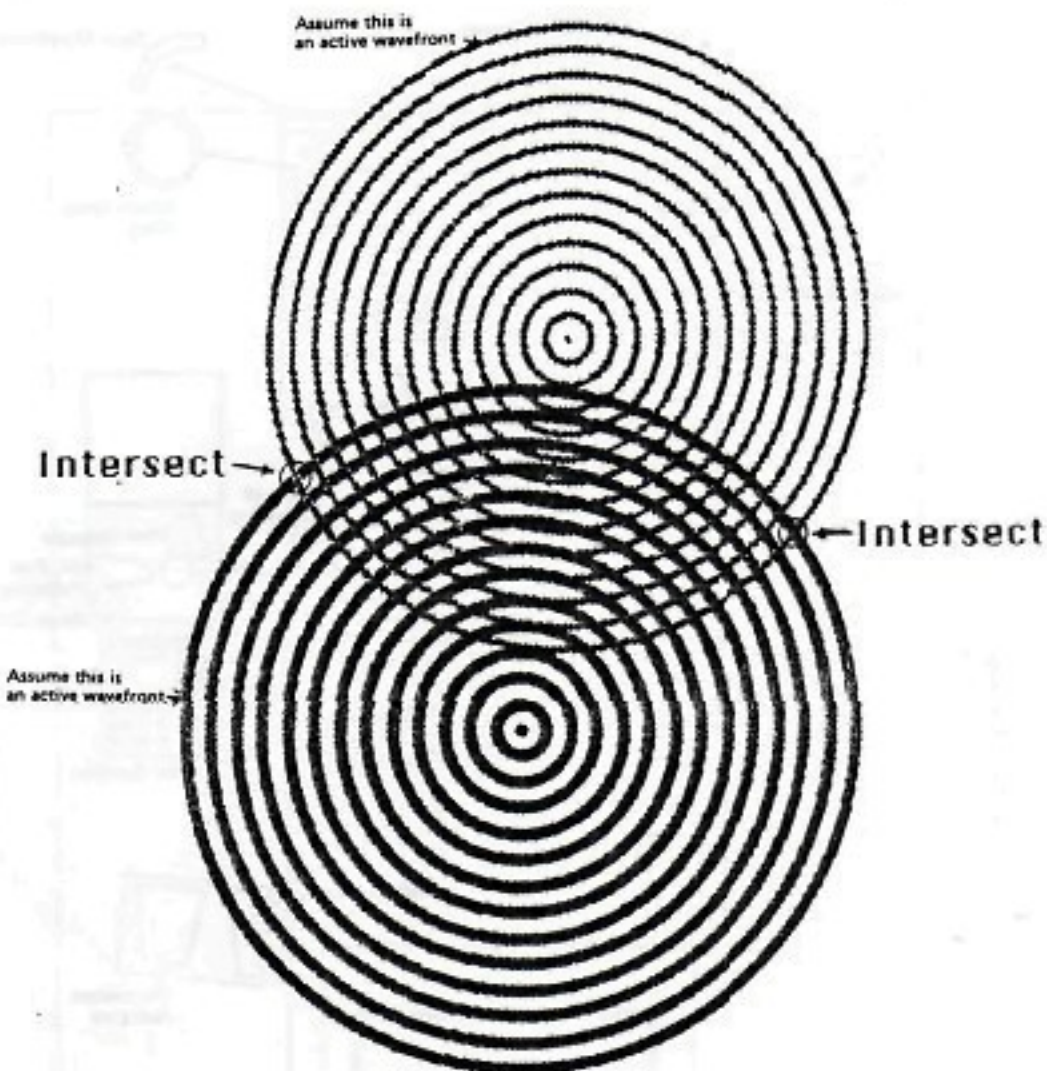

Figure 2: Wave postulation: intersection of two active monopolar antenna sourced wavefronts.

The two large events in the back of the room seemed to occur at the same time. I postulated that maybe this machine was somehow acting as two *monopole antennas*, radiating waves, as shown in Figure 2. Of a wave from radiator 1, one had the right property to interact with a wave from radiator 2, then simultaneous effects should be expected at the two intersections of the circles, especially if there was something to affect at both locations. This idea prompted me to set up additional target areas in the left walkway on the second day of the experiment.

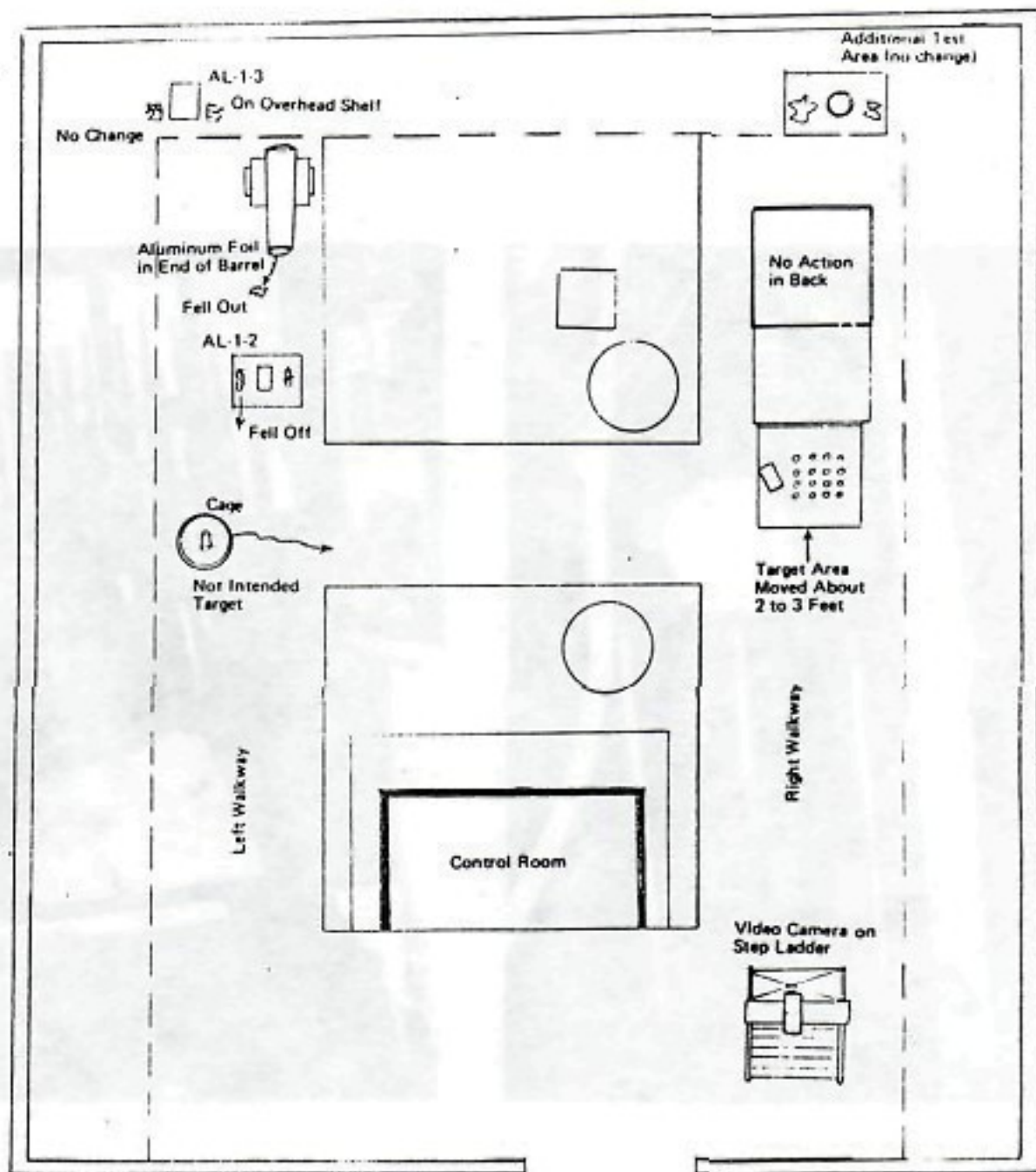

Figure 3. The set-up and noted changes for August 14, 1995 experiments

I took all of our samples back to the hotel with me so that I had control of them at all times. The geometry for the experiment on August 14, 1985 is shown in Figure 3. The record of events is presented in Table 2. With only one video camera, it was not possible to prove that we obtained simultaneous events. However, pieces of aluminum foil did move (fall to the floor) on both walkways during the evening. I set up the whole target area on the second day. I checked under the table for other equipment -- none. I moved the front table back about two or three feet from where it was on the first day. Hoping to get the major effects on the samples I took.



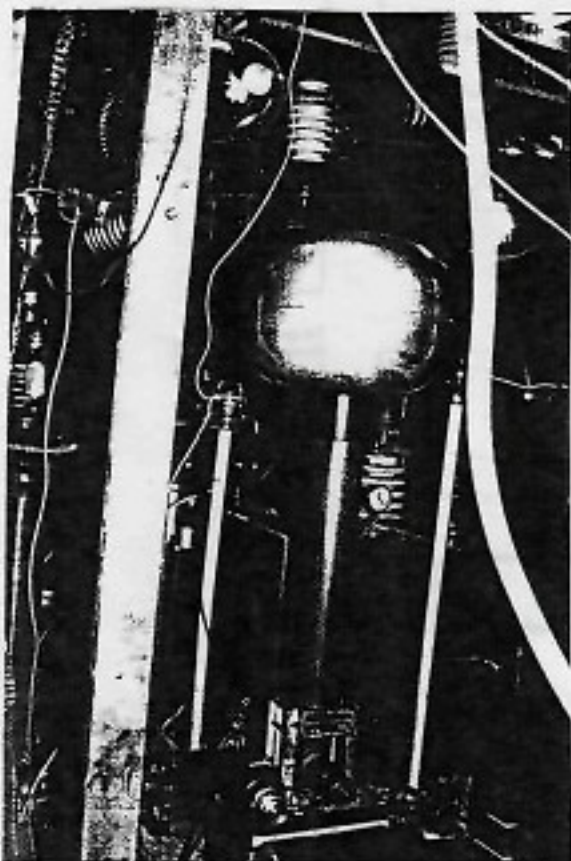

Photo 5: Tesla coil and the Van der Graff generator.



Photo 6: Objects fallen on floor towards end of experiment, left walkway.

Photo 5 was taken from the target area toward the front of the room capturing one of the Tesla coils and the Van de Graaff generator.

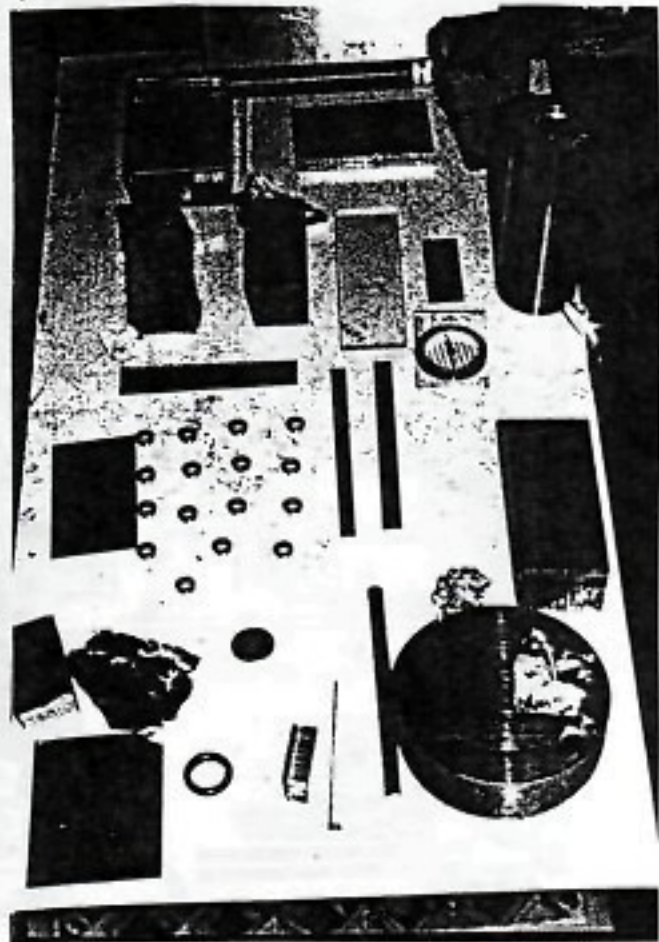

Photo 7: Hutchison samples, 2nd try

Photo 8: Jack Houck samples, 2nd try

Photos 7 and 8 were taken before the experiment on August 14, 1985 of the back and front tables, respectively, in the main target area. During my introduction for the video camera, I accidentally moved the aluminum foil ball and the plastic rod (as noted in Photo 8). I put a piece of aluminum foil in the cannon mouth, shown in the background.





Photos 9 and 10: indications of movement of magnets and aluminum objects.

Photo 9 was taken at the break. A new video tape was also put in the recorder at this time. Photo 10 was taken of the same area (front table in the target area) at the end of the experiment. Examination of the sequence of Photos 8,9,10 shows the movement of the magnets and the aluminum objects. Photo 11 verifies that nothing on the back table in the target area moved. Fortunately, some movement did occur in the area of our samples on the second day. However, nothing lifted off or hovered as I had hoped. The video record does show impulsive type movements, and there does seem to be a

preferred movement direction in local areas of the general target area. Most of the objects moved from right to left, toward the equipment; however, in one area, the movement seemed to be generally toward the front of the room.

Time	Event
8:09 p.m.	Equipment turned on.
8:19 p.m.	Spark gap not set properly – turned off machine.
8:24 p.m.	Turned on machine again.
8:27 p.m.	Lights off (camera off).
8:29 p.m.	Fuse blew – operational again.
8:31 p.m.	Piece of aluminum fell at the same instant that spark occurred
8:38 p.m.	Shutting down system to test transformers.
8:40 p.m.	Turning on system.
8:50 p.m.	Magnet array seemed to have moves to left. Aluminum foil in front of little magnets had moved.
8:53 p.m.	3 pieces of aluminum foil jumped off to left (again at spark).
9:40p.m.	Foil on left side of room/front box fallen onto of box
9:45 p.m.	Noticed piece of aluminum foil leaning on metal in front of radio.
9:56 p.m.	Shut down machine.
Break	Took pictures. Replaced video tape.
10:37 p.m.	Turned on machine.
10:50 p.m.	Block of aluminum in front/left moved over toward left edge.
11:05 p.m.	Turned off machine for gap test.
11:13 p.m.	Turned on machine.
11:21 p.m.	Shut down machine and video camera to clean heads on <i>Van der Graaff generator</i> .
11:30 p.m.	Turned everything on again.
11:40 p.m.	Gun moving – not in target area.
11:53 p.m.	Turned off machine.
11:53 p.m.	Turned equipment back on.
11:58 p.m.	Something falls (brass gauge).
12:14 a.m.	Stopped for evening.

Table 2. Table of events on August 14, 1985

### Section 3: Comparison with PK Phenomena

During the experiment on August 13 and 14, 1985, there was a great deal of randomness in both time and space of the events. My observations during these experiments, plus the many stories told to me by Pezarro and Hutchison, caused me to note the striking similarity between the *Hutchison Effect* and the psychokinesis (*PK*) phenomena. In fact, one of the possible explanations for the observed phenomena might have historically been called poltergeist, since objects seemed to randomly come flying off shelves. In this section, I will attempt to describe what I believe are the similarities and dissimilarities between the *Hutchison Effect* and *PK*. Since the hard science community does not accept *PK* phenomena, this section will have to be considered a comparison between anecdotal data about the *Hutchison Effect* with anecdotal data about the *PK* phenomena. However, I have been researching *PK* phenomena for a number of years and have personally observed a lot of *PK* phenomena, and have read and heard about a lot of other *PK*-type events.

#### 3.1 Similarities

As reported in Section 2, the *Hutchison Effect* occurs fairly randomly in the time and space. While it is true the Pezarro and Hutchison have found a preferred target area. Their effects occur all over the room. They also report events occurring outside the room. In fact, coincidentally, a water main burst in the street in front of Hutchison's residence near the end of the experiment on August 14. This type of randomness of not knowing exactly where the effect will occur in both time and space is very common in *PK* research.

The aluminum foil moved in short, jerky increments as observed on video tape. This type of motion is similar to that observed in telekinesis where objects seem to move in short, jerky increments.

In the more recent configurations of their experiment, Pezarro reported a lot of metal bending and breaking and not much levitation. The aluminum bar may have bent during the experiment on August 13; however, since I had not seen it before it came flying off the shelf, I cannot verify its unbent condition. Pezarro reported metal bending in "waves" (*i.e.*, bending back and forth). Interestingly, a number of us who have given *PK* Parties have also observed similar metal bending in the *Graduate School* (spontaneous bending) part of the *PK* Parties. Pezarro also reported metal turning black, which is also a phenomena I have observed at *PK* Parties. Pezarro had samples of metal that appear to have exploded, and he describes some of these events as happening slowly. Similarly, he reports that objects tend to break in regions of high stress. These observations are very similar to my observations during *PK* Parties, and are consistent with the idea that somehow energy is dumped into the metal grain boundaries, causing temporary melting of those grain boundaries. Thus, internal stress is relieved resulting



in the metal bending, and sometimes sufficient internal heat is generated to cause objects to explode.

Pezarro reports objects levitating and sometimes lifting off rather quickly. Even though I have not personally witnessed this effect from either the *Hutchison Effect* or the *PK* research, there certainly are a number of reports of objects levitating from Pezarro and parapsychology researchers.

Similarly, Pezarro reports examples of transmutation elements. He had a piece of steel analyzed that seemed to change to FeSi after it was exposed to the "field".

Also, he provided me with a piece of iron that seems to have experienced heating at the bend. It broke while being exposed, and it appears to have copper embedded in just the region of the break. The analysis of that piece is not yet completed. Transmutation of elements is something I have not personally observed; however, it is reported that "special people" (i.e., some of the Indian gurus) have been able to do this. I have talked with one individual who claims to have observed **Shi Baba** turn a silver plated watch to gold. It belonged to someone who had gone to India to meet Shi Baba.

There also seemed to be some psychological comparisons between the *Hutchison Effect* and *PK* phenomena. Both seem to be very elusive when skeptical scientists are around. There also may be comparisons related to emotion when events occur, and with the ability of individuals to "release" their minds from the experiment in progress.

### 3.2. Dissimilarities

*PK*-type activities are generally associated with humans. It is associated that the human mind somehow goes out to a potential target and somehow arranges the local energy to create an observed affect (sometimes controllable and sometimes uncontrollable). The *Hutchison Effect* seemed to be stimulated by some combination of the electrostatic, magnetic, and electromagnetic fields. It is possible that some of the observed effects might have been caused by conventional induction of eddy currents, or an accumulation of charge due to the electrostatic field. I did not witness any evidence of fraudulence, and am aware of some of the possible "tricks"; however, I am not an expert in electrical and magnetic phenomena and, therefore, conceivably could be duped. On the second day of the experiment, I did personally set up all of the target area as well as had postulated effects in other areas, and I set up targets in those other areas. Furthermore, if there had been a midget hiding in the back of the room, somehow arranging the other effects, he must have a tremendous amount of courage due to all the high voltage equipment around and the likelihood of being "zapped".

In the Hutchison experiment on August 13, 1985, we observed large simultaneous events on both sides of the back of the room. This type of simultaneous multiple events, separated by a significant distance, has not been reported in the *PK* literature to knowledge. However, I suppose some of the wild poltergeist-type events may have similar data.



It was interesting that some of the reported effects described by Pezarro occurred with annealed metal. Observations from my *PK* research have indicated that it is extremely difficult for people to affect annealed metal. However, if the Hutchison machine is some type of *PK* amplifier, then it is conceivable that the observed effects are just bigger than can be generated by individuals or group of people.

#### **Section 4: Recommendations**

In summary, I suspect that the *Hutchison Effect* is a real phenomena, and is a result of electrically stimulating some type of energy to affect objects. These effects have similarities to those observed in *PK* research. I cannot absolutely rule out the possibility that Hutchison and/or Pezarro are unknowingly creating the effects with their minds. The *Hutchison Effects* were generally larger than I have observed from individuals or groups, but not necessarily greater than those reported in the poltergeist literature. I consider it extremely unlikely to be a fraudulent activity.

The following is a list of things that could be done which might help to obtain a better understanding of the *Hutchison Effect*:

- \* Develop control of effects in a target area, with continuous recording of variations of the controls (parameters) and instrumentation.
- \* Make temperature measurements in the target region.
- \* Develop new equipment that is movable so that the geometry of the elements can easily varied.
- \* Determine if effects can be achieved without Hutchison present, and without him knowing of the event (i.e., rule out *PK*).
- \* Concentrate on a lifting effect.
- \* Test strips of aluminum with known amount of prestress.

Research of the *Hutchison Effect* should be funded when a sound theoretical and experimental program plan is proposed. This data may be useful in the development of a theoretical model to extend our understanding of Physics.

#### ***Letter from Hans-Adam Liechtenstein***

7 march 1990

Thank you much for your letter of February 1, which I have only now the time to answer. I was away for two weeks and wanted to speak with George Hathaway before. He showed me the video of your very interesting experiments. The problem I see is that we do not know if the effect is produced by the complicated machinery or an extraordinary parapsychological talent you personally have. To answer this question one would have to start a very serious research program. At the moment George Hathaway and I do research in a different area. Nevertheless, I think that in the future we might spend some time and money to research the *Hutchison Effect*. As I am rather busy at the moment I would suggest that you stay in contact with George Hathaway, who is directly responsible for the research and who works out the different propositions to me.

## 2) The Electromagnetics hypothesis

### ***Letter from Hathaway Consulting Services, Toronto***

November, 1985

The best explanation for the lift so far came from **Leon Dragone** and Prof. **Panos Pappas** who postulate a charge coherence between a localized area on the earth (or "launch platform" and the specimen to be launched). This sudden coherence could affect the gravitational pull on the object and give it a thrust if properly directed. It could be stimulated by sudden discharges in spark gaps as you have. But unless these gaps are precisely turned and coordinated in phase, the lift phenomenon resulting would appear only sporadically, i.e., when a chance coherent state was achieved during spark cycle.

### ***Letter from Prof. Dr. Panos T. Pappas, Athens***

October, 1985

As I have experimentally observed gravitational like (attracting) forces between identically excited by microwave bodies, your experiments gave me the idea that you probably disturb the microwave resonance between the orbiting electrons in the mass of earth and orbiting electrons in the mass in various objects. As a result you extinguish the coupling which we know as gravity between object and earth (or even cause repulsion). I will not go into details.

### ***Letter from Prof. Dr. Panos T. Pappas, Athens***

January, 1990

I believe the effects were produced by a few elements, i.e., by the *Tesla coils* and sparks in tune and perhaps, by the static [*Van der Graff*] generator. The underlying principle should be simpler, however, having so many equipments the essence is lost. The essence, I believe, was around the sparks and devices that they produced them.

## **Richard Sparks**

Scientific and Technical Intelligence / SBIR, Ottawa

### **The Experiment**

A complex high voltage, high frequency apparatus was assembled which when properly adjusted caused various material objects to accelerate in a vertical direction, against the gravitational field. Under some set of as yet undefined conditions, and particularly when " lift " does not take place, a target specimen will be fractured or disrupted in a catastrophic manner. A less frequent phenomenon is the apparent heating to incandescence of iron and steel specimens having high length to width ratios. This event is not accompanied by the heating, charring or the burning of combustible materials in contact with the specimen throughout the duration of the event of about two minutes. The fracturing of certain iron and steel geometries accompanied by an anomalous residual magnetic field, permanent in nature, is not uncommon. Permanent and dramatic alterations in the physical and chemical structure of certain metallic alloys have been documented via mass spectrographic data. These effects do not appear to be specific to any particular type or class of material.

The reaction area comprises a roughly circular cylinder about one and one half feet in diameter and of unknown height. Total energy radiated into this cylinder is on the order of a few watts, although approximately 500 watts are dissipated by the apparatus.

I have made the following observations and specified certain relationships pertaining to the action of the combined static and dynamic electric fields on an aluminum specimen of rectangular geometry and measurements of approximately  $\frac{1}{4}$ " x  $\frac{1}{2}$ " x 2".

The aluminum specimen was disrupted as shown in the appended photograph. The nature of the disruption is such that the material that comprises about one third the total mass of the specimen is shredded in a regular manner along the length of the object, resulting in a conversion, throughout the entire volume of the central portion of the specimen, from solid extrusion to an expanded bundle of more or less uniform " ribbons" or filaments of aluminum. The filaments vary in width from about 0.010" to 0.050" and in thickness from 0.008" to about 0.012".

The entire event volume has expanded outward from the mass center in seeming reaction to a force of mutual repulsion between filaments. The expanded filament bundle has assumed the shape and configuration of a magnetic field having it's axis oriented along the specimen. Such a field pattern would be produced as the as the result of a circular flow of electrons around the axis of a ferromagnetic specimen of identical geometry. The "field" lines frozen in the aluminum filaments are functionally identical to those observed at the point of fracture of a permanent iron bar magnet of the same geometry. The force exerted on the aluminum filaments was sufficient to split a large number of the outermost strands and fold them back along the "field lines " to such a

degree that layers of them are compacted together against the solid surfaces of the specimen adjacent to the event area.

The material within the event volume is much harder than the original extrusion alloy, which was quite soft, and is quite brittle. All surfaces evidence a mottled appearance, regular structure and none of the characteristics associated with plastic deformation or melting. Physical characteristics are typical of crystalline materials sheared along bonding planes. The number of filaments probably exceed 100,000; effectively increasing the surface area within the event by about 11,700 times. The initial cross section area to surface area of the event volume has increased about 78,000 times.

1. I would conservatively estimate that the energy required to accomplish the physical separation and expansion to be in the vicinity of at least 3000 Watt-sec. Under certain circumstances the requirement could be greater by two orders of magnitude.
2. Given the approximate 500 Watt input to the apparatus and the omnidirectional method of energy projection, the energy incident upon the target specimen are several orders of magnitude smaller than would be required to disrupt it.
3. If we wish to theorize that the 500 Watt RF energy field is in some fundamental way causative, it must be noted that both E and H wave components traveling in a conducting medium are attenuated by the factor ( $e^{-az}$ ) as they advance along z. The attenuation is extremely rapid and varies according to the expression:

$$\mathcal{E} = 1/a = 1/\sqrt{\pi \cdot f \cdot u \cdot O} \quad (M)$$

Generally speaking,  $Z = 5.0$  defines the point at which the function  $\mathcal{E}$  can be assumed to be zero. This function applied to the target specimen indicates a skin depth of about 64 micrometers.

4. Any theory requiring fundamental causation from the RF field is simply untenable.
5. By definition the *Van De Graff* field is static and cannot be considered as a source of fundamental causation of the phenomenon.
6. It is evident from observation and experimentation that neither shearing nor stress in tension or compression could have been causative in the observed disruptions.
7. The state of the specimen is consistent with the idea that an impressed force acted from within the specimen, perhaps from an origin at the center of mass.
8. Said force was impressed at, or rose to, the peak value required to disrupt the specimen and declined rapidly with rupture and subsequent expansion.



9. We may be able to infer a fundamental relationship between the observed phenomena and the mass of the target specimen.
10. We can infer a fundamental relationship between the observed phenomena and the *GEOMETRY* of the specimen. This is supported by the observation that target specimens of identical composition, but having different geometries are either not affected or are affected in different ways. Additionally, the effects due to a certain geometry are repeatable with identical geometries given the same type of material.
11. If we entertain a small transition in thought and accept the idea that according to mathematical constructs space itself has a real and definable structure, we can submit the possibility that the observed phenomena in some way a function of the geometry of space occupied by the specimen, and that the geometry of the specimen and the geometry of the occupied space are coupled at the level of the fine structure.
12. If we can define the nature of matter in terms of its energy equivalence and then relate the resulting system to the fine structure of the occupied space, we may be able to define the precise nature of the coupling and thereby define the mechanism of the dynamic system resulting in the observed phenomena as integrated functions of the couple and the electromagnetic operators.
13. For numerous reasons, both nuclear forces may be discounted as being fundamentally causative. The remaining force; that of gravitation, varies by Vallée's definition according to the expression;

$$Gp = c^2 \times k \times m / r = V^2$$

and is several order of magnitude smaller than required to account for our observations.

14. Vallée does predict a depletion of energy in the structure of space in the vicinity of an Earth-sized concentration of mass of 57000 megaJoules less per cubic meter than that of a cubic meter of interstellar space. If this is so, and the potential does exist, the energy available to produce the observed effects would be of the proper magnitude, assuming less than 100% conversion efficiency of our apparatus, and given the dimensions of our target specimen. This being the case, we can assume that the more massive the target specimen, the greater the potential energy flow.
15. Serious considerations should be given to the idea that exceeding a certain critical mass of any relatively pure material may result in a reaction that is not self-quenching.

## George D. Hathaway

### Historical context and relation to current Physics.

Although an attempt will be made to treat the "lift" and "disruption" aspects of the device separately, many areas of overlap will be inevitable. In general, the disruption phenomena will be analyzed in terms of invoking channeling or triggering large amounts of electromagnetic (EM) energy right in the core of materials, the lift phenomena in terms of examining both experimental evidence and *Neo-Maxwell* theories which have not been examined in sufficient detail until recently.

Until detailed measurements are made, even these tentative analyses will remain highly speculative. The intent here is to provide an initial, brief compendium of scientific and experimental investigation that appears to have the most bearing on the phenomena.

For the past dozen or so years, the latter work of American inventor **Nikola Tesla** has been under investigation by J. Hutchison, an inventor working for *Pharos Technologies*. *Pharos'* present invention consists of a particular combination of DC field-producing elements (e.g. *Van der Graaf generators*) and AC elements (e.g. *Tesla coils*). Although the actual discovery of the effects discussed herein was fortuitous it had a solid background of experimentation behind it.

As far as the lift effect is concerned, there are many other candidate systems, both conventional and non-conventional, that appear to bear some similarity, however remote. Aluminum disk are regularly suspended by *eddy currents* above toroidal AC electromagnets in first-year physics classes. Magnetic levitation trains are an engineering reality. Even with high-energy electrostatic repulsion significant lift capability is possible. They all differ from the *Pharos* device in that they:

- i) have generally much lower lift per Watt figures.
- ii) act on specific materials (conductors in the first two cases, dielectrics in the third case).
- iii) generally act vertically only using cantilevered elements directly above and/or below test objects.
- iv) cannot produce the entire range of observed phenomena.

*Pharos Technologies* Ltd. has investigated claims made for many non-conventional lift technologies and has assessed their technical and commercial feasibility. Appendix A outlines several of these.

Interesting as all of these are, however, they do not match the present invention's capabilities.

Concerning the disruption effect, several possible agents exist which can produce somewhat similar effects including lightning, smelter pot-lines, particle accelerators, RF heating etc.. Again these require the use of very high electrical power at close proximity in contrast to the present device.

As is well known, [Albert] Einstein's fondest hope was to develop a unified field theory incorporating gravity into electrodynamics. Many theorists since have considered extensions of relating theory which may approach this goal, for instance the work of Moffat at the University of Toronto who has claimed some success in the area.

While searching for the *Grand Unification*, several relativity theories have postulated actual mechanisms whereby such thing as antigravity may be possible. Appendix B contains a short bibliography on some of the more important contributions in this area. Penrose postulates a different kind (shape) of the Einstein space-time continuum which leads him to speculate about the possibility of interaction with the gravitational field. Forward, in his series on antigravity, discussed construction of huge stationary or rotating masses near the earth to provide the necessary effects. Holt invokes high energy intersecting electric and magnetic fields to alter the local space-time fabric so as to create tremendous propulsion. [J. M. J.] Kooy's gravitons, created in the Big Bang, may be absorbed by alterations in atomic structure so that force may be obtained directly from space. [René-Louis] Vallée's extension of [J. C.] Maxwell's equations led him to reduce a precise and verifiable relationship between EM fields and gravitational potential. This allows him to theorize that EM induced gravitational interaction is possible. Zeldowich arrives at a similar conclusion using neutral field interaction.

All of these hypotheses rely on super-large masses, extremely high EM field strengths or high speed rotating systems to pinch, fold or alter the local space-time fabric. However, under laboratory conditions [G. M.] Graham and [D. G.] Lahoz have observed free EM angular momentum in vacuum, implying space has a "structure" which has mechanical properties as postulates by Maxwell. It also implies the physical reality of the *Poynting vector*.

Work of similar nature was theorized by [E. G.] Cullwick which was, in turn, the basis for experimental work by W. J. Hooper, late Professor of Physics Emeritus, Principal College. By demonstrating that there were, in reality, three distinct electric fields (and three magnetic) he was able to fabricate a device which generated one of these field. This field had properties sufficiently similar to gravity (attractive to matter, impossible to shield etc.) to allow him to hypothesize that the local gravitational field may be altered so as to permit anti-gravitational field may be altered so as to permit anti-gravitational propulsion as well as energy extraction from it.

[Rudolf G.] Zinsser has developed an experimental device which uses coupled EM fields to produce local gravitational field anisotropy. These EM fields simply act as "

triggers" to induce a long-duration-propulsive effect which, Zinsser calculates, comes directly from the surrounding gravitational field.

While the foregoing techniques may seem quite divorced from current technical capability, the production of matter and, indeed, energy from the vacuum seems to be undergoing much more scientific scrutiny (see also Appendix B). Articles abound in respected journals with such titles as *Something for Nothing*, *Search for the Sparking of the Vacuum*, *Decay of the Vacuum* etc. Most develop the general theme that in the presence of presence of extremely high electric fields, such as in the vicinity of a super heavy nucleus ( $Z=150-400$ ), particle pairs (e.g. electron-positron) will be spontaneously produced from the vacuum. Application of a constant magnetic field would tend to cause this current to flow in a wire, creating energy. *Zero-point energy* or random electrodynamic theory ([Timothy H.] Boyer), which uses classical electron theory of Lorentz and field theory of Maxwell, is the starting point for examining whether electrical diodes, for examples ([Moray] King). Most of these techniques require either extremely high EM fields or extremely low-noise, high frequency rectification and [Elizabeth A.] Rauscher has shown that there may be areas of self-imposed stability and/or frequency windows (e.g. sub-harmonics) through which potentially prodigious amounts of energy may be obtained and converted for use.

[René-Louis] Vallée postulates a high-frequency energized medium from which tremendous amounts of energy may be obtained as well as [Gustave] LeBon.

[Tom E.] Bearden, developing the earlier work of Tesla, Nisbet and [Sir Edmund T.] Whittaker, shows how every EM wave can be decomposed into 2 or more simpler, scalar components. These *scalar waves* as he calls them, are able to penetrate matter and travel with limitless velocity due to the fact that, arising from scalar or potential fields only, they can carry no energy. However, it takes energy to create them and upon *their coupling back into vector EM waves, energy can be produced, effectively at a distance*. The sun is a powerful scalar wave generator for example, as are parts of the earth. Indeed, Bearden believes that gravity itself is a scalar wave-related phenomenon. This being the case, large amounts of useful energy may be able to be obtained from all these sources by the use of a small, "trigger" energy, much as Zinsser uses.

A research associate of *Pharos Technologies*, A.B.Taves, has recently developed a working hypothesis which may have some bearing on the theoretical understanding of the invention.



## Appendix A

The following compilation is based on extensive investigation by G. D. Hathaway, P.Eng., Pharos Technologies Ltd.. The most prominent references are outlined below in approximate chronological order:

- resonant quartz crystals whose lattice structure has been permanently expanded by impressed high-power asymmetric RF frequencies. Recent claims by Indianapolis inventor [Jerry G. Gallimore: *Anti-gravity properties of crystalline lattices*, *Planetary Association for Clean Energy Newsletter*, Vol. 2(4&5), February, 1981] to have duplicated not substantiated. See also: *Radio Umschau*, Vol. 14, April 1, 1927, p. 218-20. *Ueberwindung der Schwerkraft? Ein neuer Erfolg der Quazkristallforschung*, and *Science and Invention*, September 1927, *Gravity Nullified*.

- the tendency for highly charged capacitors to exert a thrust in the direction of the positive plate regardless of orientation (the "Biefeld-Brown" effect). See U.S. patents of T. Townsend Brown, e.g.: # 1,974,483, # 2,949,550, # 3,018,394, # 3,022,430. See also: Rho Sigma [Rolf Schaffranke] *Ether Technology*, 1977.

- creation of locally anisotropic gravitational fields by means of phased/ramped EM fields induced in matter as demonstrated by Rudolf Zinsser of Germany at the *First International Symposium on Non-Conventional Energy Technology*, University of Toronto, October, 1981 [published by the Planetary Association for Clean Energy].

In addition to these, two important patents should be mentioned:

- U.S. Patent # 3,626,605, Henry W. Wallace, *Method and apparatus for generating a secondary gravitational force field*, 1971, uses slowly precessing  $\frac{1}{2}$  integral spin nuclei material (e.g. brass) high speed gyroscopes.

- France Patent # 1,253,902, Marcel Pages, *Cosmic flight machine*, 1961 (see also Pages: *Le défi de l'antigravitation*, Editions Chiron, Paris 1974) uses EM "Magnus" effect on particles in a modified cyclotron accelerator.

Reported, but unconfirmed, experimentation has taken place by J. J. Searl in Britain (see *Ether Technology*), J. Dean of Spokane, Washington (using an advanced *Biefeld-Brown* effect). Otis T. Carr of New Jersey, expanding on Nikola Tesla's last works, S. Hurwich of Toronto, on gun-jammers allegedly used by Israel in Entebbe raid for producing a directed inertial field.

## Appendix B

The following bibliography presents a brief list of key researchers. The first section deals with gravity and propulsion, the second with energy. In many instances there will be an overlap between the two.

### Gravity & propulsion

Holt, Allan C. *Prospects for a breakthrough in field dependent propulsion. Proceedings, AIAA 16th Joint Propulsion Conference.* July 1980. [AIAA-80-1233.]

Forward, Robert L. *Spinning new realities: Theorist Roger Penrose gives Einstein's universe a new twist. Science* 80. 1(8), Dec. 1980. p.40-9.

Wheeler, John Archibald. *Superspace and the nature of quantum geometrodynamics.* In: **Topics in Non-Linear Physics.** Edited by Norman J. Zabusky. Springer-verlag, 1968. p.615-64. [Proceedings of the. Physics Section, International School of Nonlinear Mathematics & Physics.]

Rho Sigma [Schaffranke, Rolf]. **Ether-technology: a rational approach to gravity-control.** [discusses B. Heim's work amongst others]. 1978. p.108

Heim, Burkhard. *Die dynamische Kontrabarie als Lösung des Astronautischen Problems.* Public lecture, Stuttgart (1952) and 2nd International Congress for Astronautics, Innsbruck, Austria. 1952.

Zinsser, Rudolf G.. *Mechanical Energy from Anisotropic Gravitational Fields.* In: **Proceedings of the First International symposium on non-conventional energy technology.** Toronto, October 23-24, 1981. Ottawa. Planetary Association for Clean Energy, 1981. p.295-315.

Ford, Kenneth W.. **Transfer of Energy from astronomical Bodies to Space Vehicles.** T-Division Report, Los Alamos, 1959.

Sullivan, Walter. *Gravity machine called possible. New York Times.* June 9, 1963. p.20.

Ulam, S. M.. **On the possibility of extracting energy from gravitational systems by navigating space vehicles.** Los Alamos Scientific Laboratory Report LAMS- 2219. June, 1958. [first publication on extracting propulsive energy from a moving gravitating body.]

Ulam S. M.. *On some statistical properties of dynamical systems.* In: **Proceedings, 4th Berkeley Symposium on Mathematical Statistics and Probability** (June 20-July 30, 1960). University of California Press. p.315-20.

Vulkov, K. *Astronautical generalization of the effects of relativity due to flyby of a central field of gravitation. JBIS.* Vol. 31(3). March, 1978. p.111-2.

Forward, Robert L.. *Antigravity. Proceedings IRE,* Vol. 49, September 1961. p.1942.

Forward, Robert L.. *Practical anti-gravity still far off. Missiles and Rockets.* Vol. 9. September 11, 1961. p.28.

Forward, Robert L.. *Guidelines to Antigravity. American Journal of Physics,* Vol. 31. March 1963. p.166-70.

Fuller, R. W. and John Archibald Wheeler. *Causality and multiply connected space-time. Physical Review.* Vol. 128 (2). October 15, 1962. p.919-29.

Kooy, J. M. J. *Communication - gravitation and space flight. Acta Astronautica.* [Journal of the International Academy of Astronautics]. 4(1/2), January/February 1977. p.229-30.

Vallée René-Louis. *Gravitational and material electromagnetic energy: Synergetic Model*. In: **Proceedings of the First International symposium on non-conventional energy technology**. Toronto, October 23-24, 1981. Ottawa. Planetary Association for Clean Energy, 1981. p.20-41

Zeldovich, F.L. *Electromagnetic current and charge due to interaction between a gravitational and a free electromagnetic field*. *Journal of Experimental and Electrical Physics*. [Soviet translation from *ZhETF Pis Red.* (JETP letters)] 16(7), October 5, 1972. p.425-7.

Semon, Marc and Glenn M. Schmiege. *Note on the analogy between inertial and electromagnetic forces*. *American Journal of Physics*. 49(7), July 1981. p.689-90.

Graham, G. M. and D. G. Lahoz. *Observation of static electromagnetic angular momentum in vacuo*. *Nature*. 285(5761), May 15 1980. p.154-5.

Hooper, William J.. *New horizons in electric, magnetic and gravitational field theory*. Ictrodynamic Gravity Inc., Akron, Ohio. 1974, p.86.

Cullwick, E.G.. *Electromagnetism and relativity: with particular reference to moving media and electromagnetic induction*. London: Longmans, Green & Co., 1957. p. 239-61. [especially Chapter 18.]

Alfven, H.. *Spacecraft Propulsion: New Methods*. *Science*. Vol. 176 (4031), April 14, 1972. p.167-88.

Dyson, F. J.. *Gravitational Machine*. *Interstellar Communication*. A. G. W. Cameron, Editor. New York. W. A. Benjamin. 1963. p.115-20; also: New Boston, N.H.. Gravity Research Foundation. 1962.

## Energy

Greenberg, Jack S. and Walter Greiner. *Search for the sparking of the vacuum*. *Physics Today*, 35(8), August 1982. p.24-32.

Fulcher, Lewis P., Johann Rafelske and Abraham Klein. *The decay of the vacuum*. *Scientific American*. 241(6), December 1979. p.150-9.

Davies, Paul C.W. *Something for nothing*. *New Scientist*. 94(1307), May 27, 1982. p. 580-2.

Boyer, Timothy H.. *Random electrodynamics: The theory of classical electrodynamics with classical electromagnetic and fields*. *Physical Review D, Particles and Fields*. Series 3, 11(4), February 15, 1975. p. 790-880.

Rauscher, Elizabeth A.. *Conceptual changes in reality models from new discoveries in physics*. In: **Proceedings of the First International symposium on non-conventional energy technology**. Toronto, October 23-24, 1981. Ottawa. Planetary Association for Clean Energy, 1981. p. 922.

Cercignani, C., L. Galgani and A. Scotti. *Zero-point energy in classical non-linear mechanics*. *Physical Review Letters*. 38(6), 1972. p. 403.

Lanczos, Cornelius. *Matter waves and electricity*. *Physical Review*. Series 2, 61(11 & 12), June 1 & 15, 1942. p. 713-20.

Nicolis, G. and I. Prigogine. *Self-organization in nonequilibrium systems: from dissipative structures to order through fluctuations*. New York. John Wiley & Sons. (Wiley-Interscience). 1977.

Bearden, Thomas E.. *Solutions to Tesla's secrets and the Soviet Tesla weapons*. Tesla Book Co., 1981.

## **Anonymous (D. Scott Rogo ?)**

### **Hutchison Effect**

The cause of gravitation has been a challenge to science over the centuries which up to the present defies solution. At present there are 2 ways of creating gravity as an artificial force opposite to the gravitational force of the earth so that one can measure it. The first is by centrifuges and the second is the one in which the Russians have done most of the early research in which psychokinesis techniques are used to produce the anti-gravitational field.

It is important to mention the *PK* effect which in the USA has been fully confirmed by the work done at the **Maimonides Medical Centre** in Brooklyn NY as early as 1973. While up to the present all *PK* effect makes use of sensitive there is no explanation how the very weak electromagnetic mind fields could possibly effect objects at a distance.

In the *PK* field it is accepted that the mind of the sensitive effect a totally different force field the nature of which is not understood at present. Nobody studying this work considers these fields as being electromagnetic.

Outside the *PK* work very little has been done beyond the early steps taken by **Cavendish** in the late 1790's when he measured the constant of gravitation with his famous balance.

The fortuitous discovery of the *Hutchison Effect (HE)* in 1981 at a small workshop in British Columbia might be the breakthrough which will open up the research on gravitation. The *HE* showed that with very small electrical energy inputs it was possible to effect the gravitational fields of objects at a distance. The same energy input would act on objects weighing as little as a few grams or as much as 15 Kilos. The *HE* went further it showed that this force field acted on the molecular structure of matter and would sometime instead of creating gravitational effects it caused the object to catastrophically distrust irrespective of it's material structure.

When this effect was presented to scientists it was met with a reaction which did not allow constructive observation of the effect. Most of the time experts were too busy trying to prove that the effect was impossible because it appeared to them that basic principle on which their expertise was based, was being violated.

We ourselves were caught in the dilemma except that we were very aware of the reality of the effect. The vast range of destroyed samples, photos, video, and films were there



to confirm the reality. To science what appeared necessary was to prove that what we were doing was fraudulent. It appeared almost like an obsession. Some universities told us that even if we were able to reproduce it before expert witnesses they would not admit what they had observed because of fear of ridicule.

We now realize that the problem arises because it is automatically assumed that we are observing an electromagnetic effect acting at a distance. Nothing could be farther from the truth. What is being observed is an electromagnetic effect of a special design which acts on a force field, at present little understood, but which is not electromagnetic in nature.

*A field which parapsychologists have seen many times activated by sensitives. Many of our small samples if shown to experts in the physics field would recognize it as such. We ourselves removed small samples which might be confusing and relate this to the work of sensitives.*

We too wanted to keep a distance between the two sciences. We now realize that acceptance of the fact that we are acting on an unknown force field without breaking any accepted principles allows everyone to examine the effect without having to defend anything in their field.

The implications in this hypothesis if proven correct would open for science new fields of investigations which would have an effect on almost all present work in energy and communications. A totally new science could develop which at present can only be speculated upon.

In the research project it would now seem necessary to include specialists from the field of parapsychology besides physics and electronics. This is to our knowledge the first time that it can be shown that this unknown but observable effect can be reproduced by electrical energy and remove this research from the field of magic to the field of reality. We will be able to create this reaction under controlled conditions and examine it from a different perspective.

## **Canadian military perspective**

### **Letter from Lorne A. Kuehn**

Scientific and Technical Intelligence, Ottawa

June 9, 1986

The report [Richard Sparks] is a fair summary of our scientific appraisal of the phenomenon that you are investigating. We do not foresee any further consideration of support to your endeavor until such time as you can assure a reproducible effect in a particular sample in a reasonable period of time (say three or four hours). The phenomenon is demonstrated to us appear to be intermittent and unpredictable.

### **Letter from Lorne A. Kuehn**

*(to George Hathaway, Toronto)*

Enclosed is a copy of my trip report, relevant to my visit to Mr. *Hutchison's* laboratory earlier this year. I have also enclosed a copy of the metallurgical report on the sample which you provided us, which I assume has been now returned to you.

The report is a fair summary of our scientific appraisal of the phenomena that you are investigating. We do not foresee any further consideration of support to your endeavor until such time as you can assure a reproducible effect in a particular sample in a reasonable period of time (say three of four hours). The Phenomena as demonstrated to us appear to be intermittent and unpredictable. Reproducibility of an effect would do much to strengthen your case.

I have enclosed some photos that we took for your retention and for passing to John Hutchison. Enjoyed meeting you and John and wish you well in your endeavours.

**Lt. Col. L. R. Larsen**

Scientific and Technical Intelligence, Ottawa

**Memorandum**

12 November, 1986

1. This document provides a summary of the series of events which culminated in Mr. Hutchison's letter to his MP [Member of Parliament].
2. The Phenomena of interest were first reported in 1979 by Mr. John Hutchison of Vancouver, a reclusive amateur inventor. Mr. Hutchison had worked for years building various electrostatic devices to explore their visual and audio effects. He is not a scientist and although his devices embody scientific principles and can be used to demonstrate various physical effects, he has kept no records of his experiments and has relatively little interest in exploring or understanding the phenomena which he encounters. In 1979 he became aware of various destructive and levitate effects that could be produced intermittently by his equipment.
3. In 1980, these phenomena became known to Mr. **A. Pezarro** of Vancouver, a businessman who was looking for novel technology for business ventures. In 1981 Mr. Pezarro met Mr. **George Hathaway**, an electrical engineer to whom he described the phenomena. Together they formed *Pharos Technologies Ltd.* (PTL) to exploit it and retained Hutchison as a consultant.
4. They made an overture to **US Army Intelligence** and were able to obtain some funds (estimated to be \$25,000) to move the Hutchison apparatus to a warehouse in North Vancouver in 1982. Apparently a demonstration was made in 1983 to US Army and **Los Alamos** [Laboratory] officials but this was not successful and no further American funding was obtained. [Note by John Hutchison: *Half success.*]
5. The project suffered from lack of funds for equipment or facilities and overture was made to *CRAD* in *NDHQ* [National Defence headquarters] in late 1983 which proved to be unsuccessful. (It should be noted that the lack of reproducibility of the effects, their astounding descriptions, the incredulity of conventional scientists and engineers, and the lack of adequate credible presentations and demonstrations has compounded all efforts hitherto to exploit, or even to explain, these phenomena) Several demonstrations were made to scientific visitors during 1984, including ones from McDonnell-Douglas, San Diego, Fort Worth and Washington State University. None proved successful in generating funds. [Note by John Hutchison: *But worked good with support and help of US Army Intelligence Col. John Alexander*]

6. Eventually in 1985, funding support was obtained from *Mega Research* of Toronto, a Commercial business engaged in engineering related to nuclear magnetic resonance for medical applications. This group has a vigorous approach to governmental funding and has actively solicited funds from various cabinet ministers through political connections. The principal individuals involved are Mr. **Bob Jack** and Mr. **Szabo**. They were aided in their approach to *CIS* by Major **Tim Dear** of CFB Toronto.
7. At the request of *CIS* and *CRAD*, two *DSTI* staff scientists made a visit on March 23, 1986 to a laboratory in Vancouver, operated under the auspices of *Pharos Technologies Ltd.*, to witness a demonstration of novel physical phenomena. These phenomena had been the subject of several overtures to *M/DND* and *M/SSC*. Two *DSTI* scientists had also seen a film demonstration at CFB Toronto under the auspices of *Mega Research* early in March, 1986. (Officers of this latter company have interests in, and lobby for *Pharos Technologies Ltd.*)
8. The post-demonstration analysis concluded that the Hutchison apparatus and phenomena were of little scientific or practical value. A detailed report and covering letter, indicating these facts and a lack of DND interest in supporting further experimentation, were forwarded to Mr. Hathaway on 9 Jun. 86. Apparently, this was not transmitted to Mr. Hutchison, hence his letter to Mr. **Cook** [Member of Parliament].
9. All was not what it seemed to be in this whole endeavour. It turns out that Mr. Bob Jack, an individual purporting to be a financial backer for the *Pharos Company*, was actually an undercover agent for **Revenue Canada** who was investigating scientific research tax credit abuses by Mr. Szabo, or the Toronto principals who were putting money into this effort.



## ***Crystal energy convertor***

John Hutchison's crystal energy converter produced over 3 Watts of energy without any evident exterior input source or batteries. It put out from 0.5 to 1.7 volts at 880 to 3000 microAmps, and could be connected in series and in parallel to change the voltage and current. He is currently working on a new generation of such devices.

John Hutchison felt that it worked on the principle of altered space product of charge function barrier. If so, it would be a significant advancement, demonstrating a simple method of tapping *Zero Point Energy* and illustrating the *Casimir Effect*.

*Zero Point Energy*, is the energy in ordinary empty space. In quantum theory, so-called empty space is a seething sea of activity, with fields coming and going, and particles being created and annihilated on a microscopic level. *Zero-point-energy* is the remaining activity or motion left in space, even at a temperature of absolute zero -- once you "freeze out" most motions. (At minus 273 degrees Centigrade, or zero degrees Kelvin, all molecular motion stops -- and conventionally, there is no longer any energy left, except for zero-point-energy.)

This is a "mainstream concept" subscribed by Nobel Prize physicists. Indeed, it is believed by such prominent physicist as **Richard P. Feynman** and **John Archibald Wheeler** that even in less than one cubic centimeter of vacuum at the *zero-point*, there is more energy than can be produced by any power plant yet built by man, enough to evaporate all of the world's oceans ! In Victorian times, this energy field that permeates all the universe, was known by **Maxwell** as the Ether, and by **Albert Einstien** in his *General Relativity Theory* as metric plenum, and in his *Special Relativity Theory* as a true vacuum. **Heisenberg** referred to it as a plenum of vacuum field fluctuation. More popularly, it is seen as a source of "free energy".

This converter is believed to illustrate the *Casimir Effect*. **Hendrik Casimir** proved that the vacuum fluctuations really exist. Vacuum pushes plates together so much that they generate heat, and allow electrons only flow in one direction at their interface. of two *dissimilar materials*. If conditions are right such that it is easier for the electrons to go in one direction than the other across the interface and if and when there is an external circuit connection, this effect could be expected to drive current around continuously. The peculiar effect is by no means fully understood and can only be observed under certain conditions, which are difficult to define and to maintain.

The original microwave-oven sized crystal energy converter has been dismantled and is no longer available for demonstration. It weighed 53 pounds (24 kilos), and measured about 24 inches (60 cm) long by 12 inches (30 cm) wide and high. It contained a number of components, including three Barium Titanate cylinders of about 4 inches of (10 cm) diameter and a mechanical device to apply pressure to certain secondary crystals and so "tune" the model. Barium Titanate is known to be able to "capture" electromagnetic pulses somewhat as a radio picks up radio frequencies. As the crystal pulses, or resonates, it produces electric power.

Each of Hutchison's Barium Titanate cylinders had a different output of about 90 millivolts at less than one micro-amp. However the total output of the converter measured 3 Volts at 2.5 Amps DC. Although this would imply an output of 7.5 Watts, only about 3 watts of continuous power is claimed. The key to this technology lies in the secondary crystals and it is their chemical composition, arrangement and treatment which is crucial in order to achieve the generation of electrical power.

It should be stressed that this model was constructed over a short period of time and was designed more to illustrate a concept that John had envisioned. Further, it was constructed using materials and components that John had stripped from a vast range of electronic and radio equipment that he had salvaged, mainly from military surplus, and which he had accumulated over many years. It had not been designed for any robust use under adverse conditions. After many witnesses had confirmed his technology, John submitted the model to a severe testing program in order to determine its limiting characteristics. Unfortunately, it was during this testing program that the converter incurred some serious damage.

After dismantling the model, John discovered that some of the components had been badly damaged by the excessive power generated and that corrosion had developed around a number of contact points. Of particular significance, he noticed that some of the delicate crystal wafers had cracked. Unfortunately, some of these critical components, originally having been salvaged from very old equipment, can not longer be found and so the model cannot be rebuilt.

A superior, smaller and portable model was built which would meet or exceed the power output of its predecessor, but this would require precision machined components and a more sophisticated crystal structure. It was demonstrated in Hiroshima. It lit a tiny lamp and also ran a small motor.

Barium Titanate is now being replaced by selected rocks, rocks which can generate potential, somewhat after the work of **T. Townsend Brown**. Hutchison can make a "dirt-cheap" converter in a stove-top process, with common chemicals and water, a "rock soup", which, when solidified allows the drawing of electrical energy.

## INDEX

- acceleration of levitation, 23, 38, 39  
 accumulation of charge, 62  
 Alexander, John, 76  
 Alfvén, H., 72  
 annealed metal effects, 62  
 anti-gravity field, 2, 70  
 Aspden, Harold, 27  
 aurora-like lighting effect, 14  
 ball lightning projector, 7  
 Barium Titanate, 4, 79  
*BCTV*, 3, 20  
 Bearden, Thomas E., 40, 42, 49, 69, 72  
 Biefeld-Brown effect, 70  
 Boeing, 41  
 Boyer, Timothy H., 24, 69, 72  
 British Columbia Institute of Technology, 17  
 British Columbia Hydro, 17  
 Brown, T. Townsend, 70, 79  
 business ventures, 77  
 Canadian Government, destruction of lab, 3  
 Canadian Scientific and Technical Intelligence Agency, 3, 64, 75, 76  
 Carr, Otis T., 70  
 Casimir effect, 78  
 Casimir, Hendrik, 78  
 Cercignani, C. L., 72  
 CFB Toronto, 76  
 charge coherence, 62  
 Central Intelligence Agency, 42  
*CKVU-TV*, 3, 35  
 Cook, MP, 77  
 crystals, 26, 70, 78-79  
 crystal energy convertor, 78-79  
 Cullwick, E. G., 68, 72  
 Dea, Jack, 49  
 Dean, J., 70  
 Dear, Tim, 77  
 disruption effect, 2, 10, 11, 15, 64, 66  
 distance of effect, 14, 37, 41  
 Dragone, Leon, 63  
 dumbbell Tesla coil, 6, 20  
 Dyson, F. J., 72  
 eddy currents, 61, 67  
 electric power control, 6  
 Einstein, Albert, 68, 78  
*Electric Spacecraft Journal*, 4  
 electrostatic field, 61  
 Environment Canada, 42  
 ether, action of the, 27  
 experimental program plan, 62  
*Extraordinary Science*, 4  
 Feynman, Richard P., 78  
 field strength, 22, 36, 37, 64-66

Ford, Kenneth W., 71  
Fort Worth Army Command, 3, 76  
Forward Robert L., 71  
Fulcher, Lewis P., 72  
Gagnon, Jacques, 26  
Gallimore, Jerry G., 70  
geometry of specimen, 65  
globule formation, 19, 34  
Grad, Bernard, 28  
Graham, G. M., 24, 68  
Graneau, Peter, 27, 28  
gravitation force, 66  
gravity antennas, 2  
gravity propulsion, 4  
Greenberg, Jack S., 72  
Hathaway, George, 2, 13-39, 40, 48, 62, 63, 70, 75, 76  
headache during experiment, 28  
heating, 63  
heating effect, 60  
Heim, Burkhard, 71  
Holt, Alan C., 24, 71  
Hooper, William J., 24, 68, 72  
Houck, Jack, 3, 46, 47  
Hurwich, S., 70  
Hutchison, Kenneth and Margaret, 2  
interferometry, 40, 54  
International Energy, 4  
Jack, Bob, 77  
Jacob's ladder, 50  
Japanese tour, 4, 79  
King, Moray, 69  
Kooy, J. M. J., 68, 71  
Kuehn, Lorne A., 75  
Lahoz, D. G., 68  
Lakken, Dr., 8  
Lanczos, Cornelius, 72  
Larsen, L. R., 76  
LeBon, Gustave, 24  
levitation, 2, 41, 48, 60  
Liechtenstein, Hans-Adam, 62  
lift off, 38, 39, 60  
lifting effect, 10, 16, 38, 39, 62, 64, 67  
lighting phenomena, 16, 17  
Los Alamos Laboratory, 2, 17, 40, 48, 76  
Lynn Valley laboratory, 2, 19  
magnetic field patterns on filament, 64  
Magnus effect, 70  
material embedding, 60  
Max Planck Institut, 11  
Maxwell, James Clerk, 68  
McDonnell Douglas, 3, 76  
Mega Research, 76  
metal bending, 60  
metal exploding, 60  
metal fracturing, 31, 34, 63



- metal mixing with wood, 41
- metal turning black, 60
- microwave clicks, 28
- microwave resonance, 63
- Mitchell, Edgar D., 45
- Moffat, 68
- monopole antennas, 54
- multiple events, 61
- Nieper, Hans, 15
- Nisbet, 69
- non-conductive heating, 17
- nuclear unit, 8-9, 40
- Pages, Marcel, 70
- Pappas, Panos T., 63
- Penrose, 68
- Pezarro, Alexis. 2, 13, 40, 48, 50, 59, 60-62, 76
- Pharos, 2, 13, 15, 48, 67, 69, 76-77
- PK amplifier, 62
- Planetary Association for Clean Energy, 4, 70, 72
- poltergeist, 28, 45, 46, 60
- potential fields, 70
- Poynting vector, 69
- Prigogine, Ilya, 24, 72
- propulsive effect, 14, 48
- psychokinesis, 44, 60, 67, 73-74
- Raum und Zeit*, 4
- Rauscher, Elizabeth, 43, 49, 69, 72
- reaction area, 64
- repulsion between filaments, 65
- Revenue Canada, 78
- Rogo, D. Scott, 45, 46, 47, 73
- Ross, Billie, 44
- scalar waves, 70
- Schaffranke, Rolf, 70, 71
- Schmidt, Helmut, 45
- Searl J. J., 70
- "secret" elements, 50
- Shi Baba, 61
- shredding, 11, 64
- Siemens, 11, 41
- Space Power, 4
- spark gap generator, 50
- Sparks, Richard, 64, 76
- Szabo, 77
- Taves, A. B., 69
- temperature, 61
- Tesla, Nikola, 67, 69, 70
- Tesla as inspiration, 2, 26
- Tesla coils, 5, 6, 20, 21, 26, 36, 40, 48, 50, 51, 64, 68
- Tiller, William, 49
- Tokyo Free Energy Project, 4
- transmutation, 2, 18, 19, 34, 61
- TV ASAHI*, 4
- Ulam, S. M., 71
- U.S. Army Intelligence, 2, 76

University of Toronto Department of Metallurgy, 17, 18  
vacuum tube Tesla coil, 7  
Vallée, René-Louis, 24, 42, 66, 68-69, 72  
Valone, Tom, 22  
vaporization, 18  
Van de Graff generator, 12, 20, 21, 23, 26, 50, 51, 60, 63, 65, 67  
Vogel, Marcel, 23, 26  
Wallace, Henry W., 70  
Washington State University, 3, 76  
Wheeler, John Archibald, 71, 78  
water main burst, 59  
Whittaker, Edmund T., 69  
Williams, Pharis Edward, 49  
Wilson, Dr., 8  
Winfield, Mel, 15  
Yokoyama, Nobuo, 4  
Zel'dowich, F. L., 68, 72  
Zero-point energy, 69, 78  
Zinsser, Rudolf, 24, 68-69, 70, 71

2N 3429 → TO-5 CASE  
CUT OFF METAL ACT AS RAD DIST.  
- RUFF. RAD - DIST.

1990 GORDON Incomb

TAB BOOKS

DIVE McCPAWHI

CADRETT'S GOLD MINE